

MÅGEBO

en

de

fr

it

da

no

sv

fi

pt

es

el

nl

pl

lt

et

lv

ru

cs

hu

ro

sk

sr

hr

sl

bg

tr



Design and Quality
IKEA of Sweden

ENGLISH	9
DEUTSCH	15
FRANÇAIS	21
ITALIANO	27
DANSK	33
NORSK	39
SVENSKA	45
SUOMI	51
PORTUGUÊS	57
ESPAÑOL	63
ΕΛΛΗΝΙΚΑ	69
NEDERLANDS	75
POLSKI	81
LIETUVIŲ	87
EESTI	93
LATVIEŠU	99
РУССКИЙ	105
ČESKY	111
MAGYAR	117
ROMÂNĂ	123
SLOVENSKY	129
SRPSKI	135
HRVATSKI	141
SLOVENŠČINA	147
БЪЛГАРСКИ	153
TÜRKÇE	159

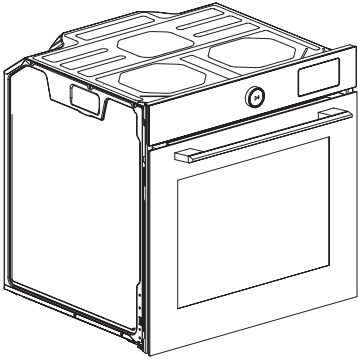

1x

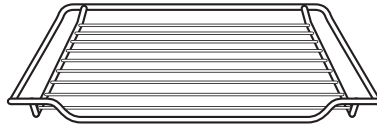

1x

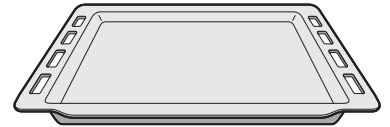

1x

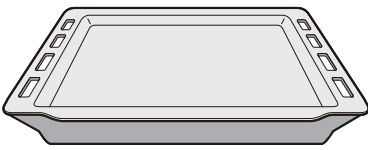

1x

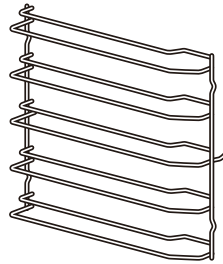

2x

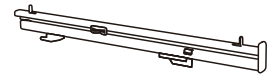

2x

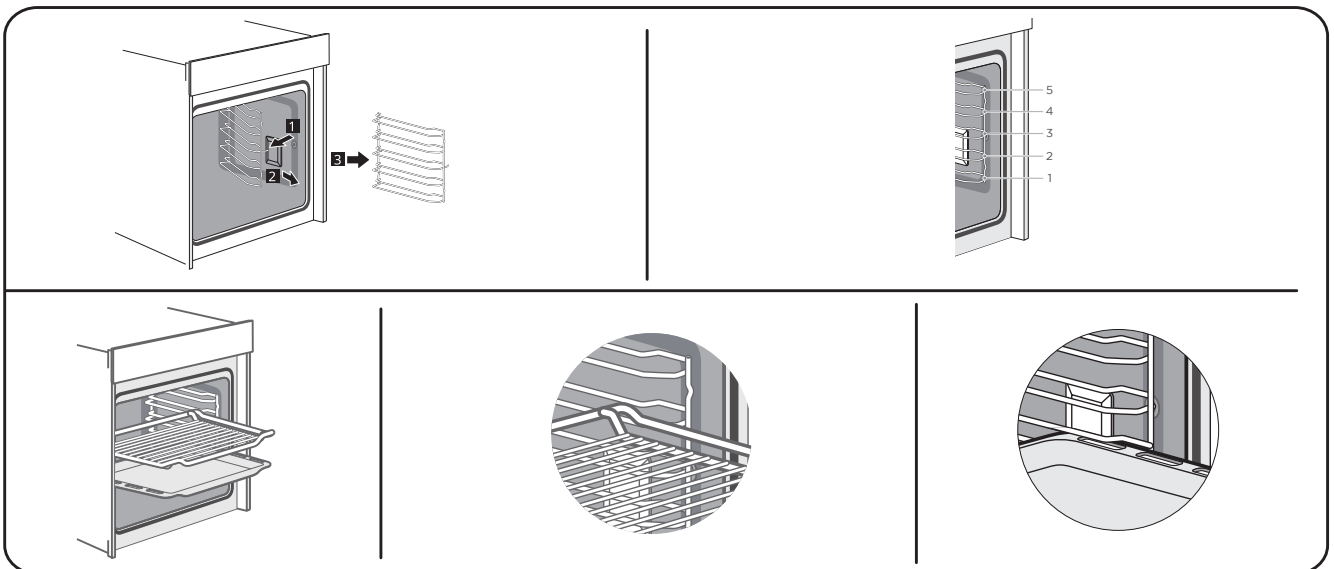
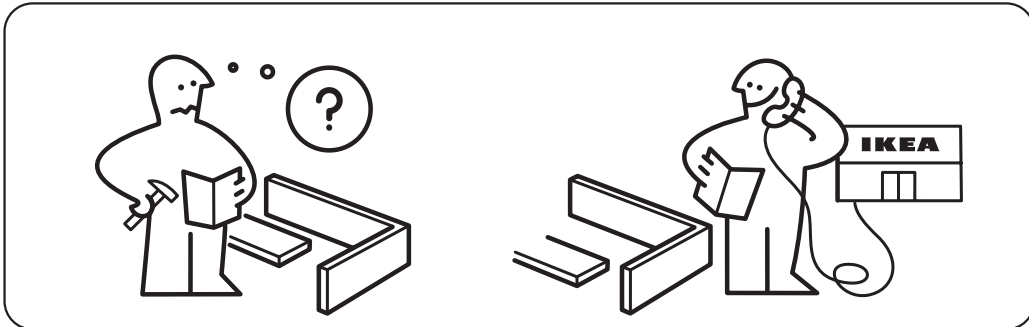

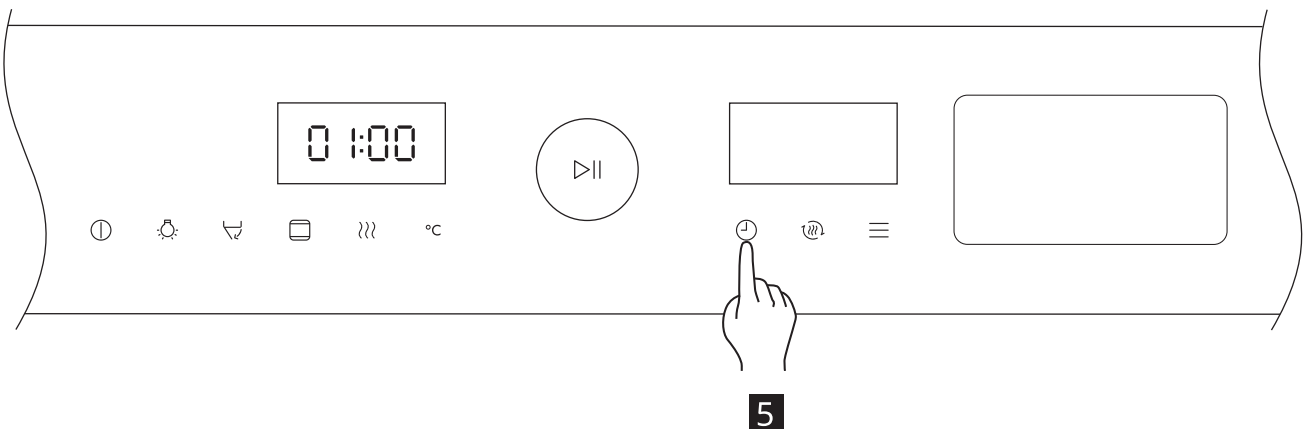
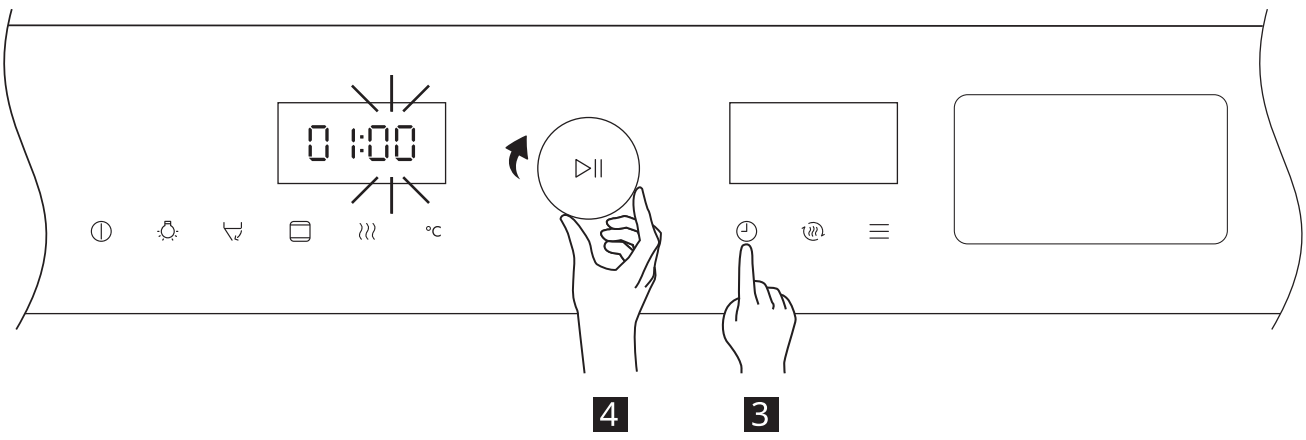
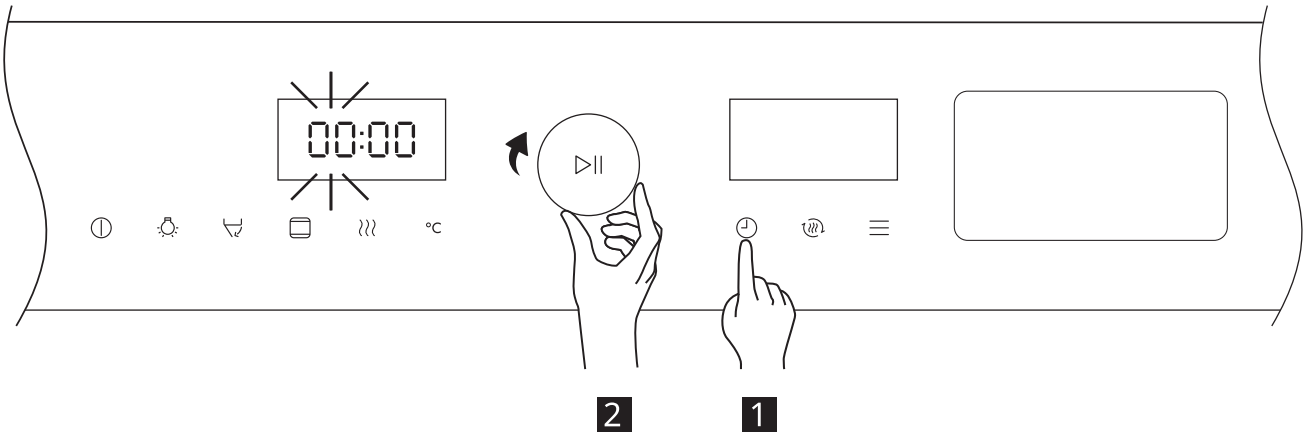
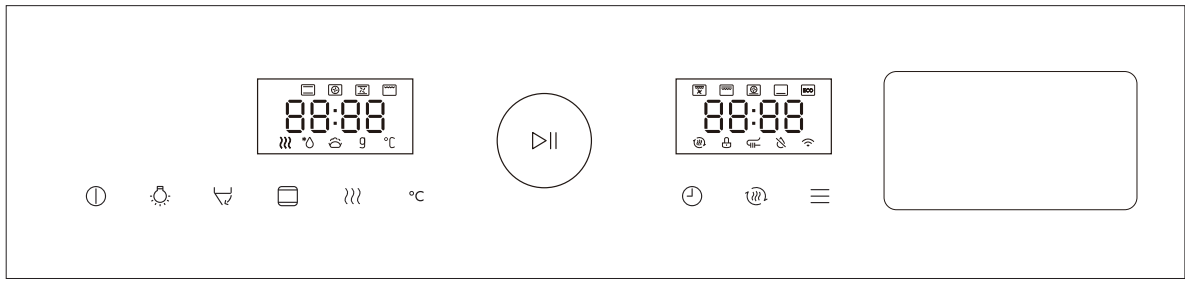

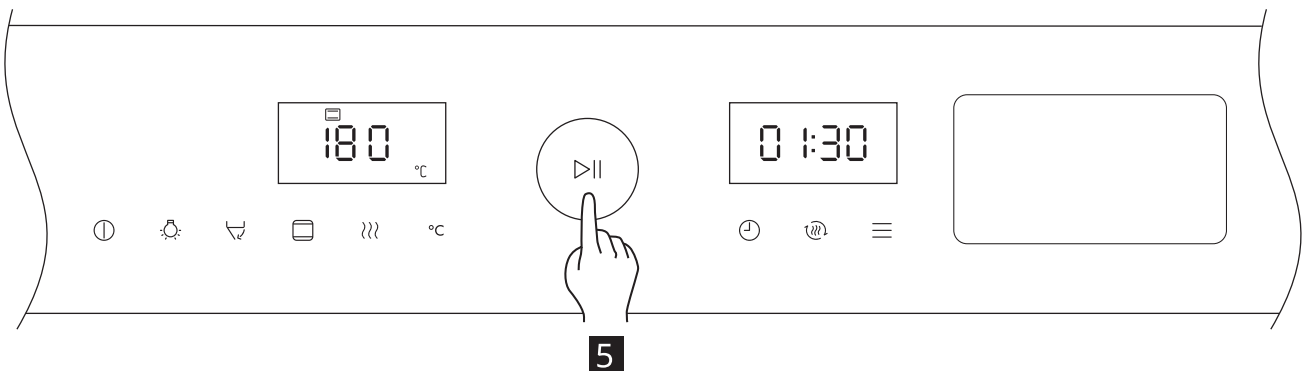
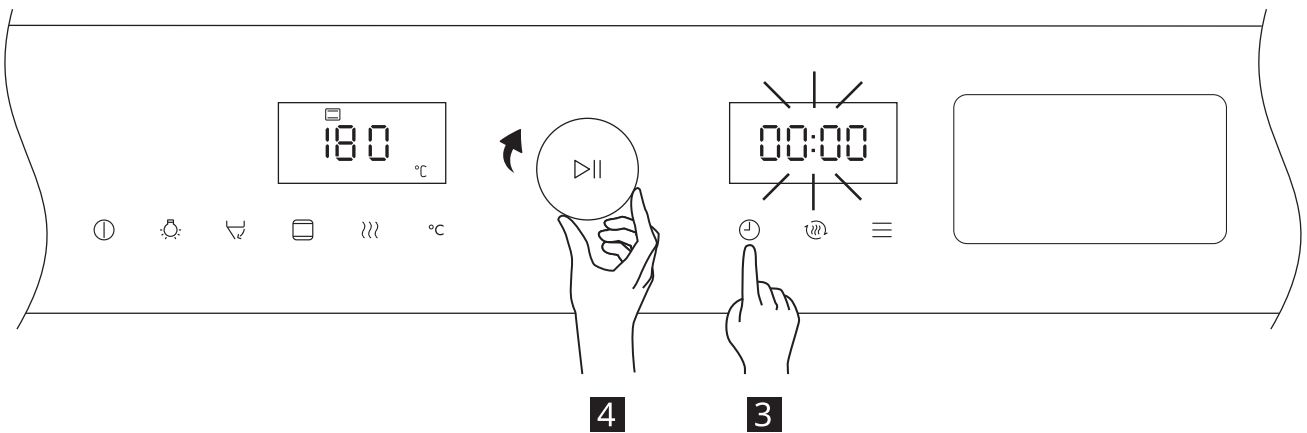
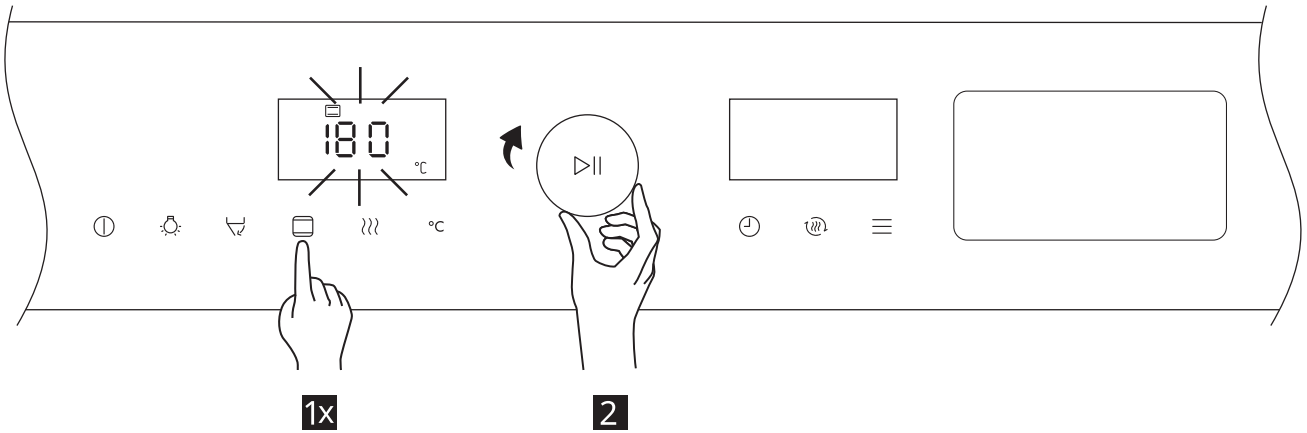
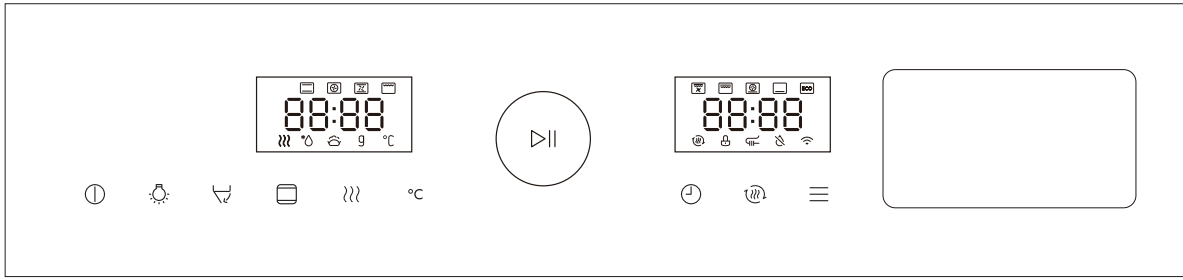

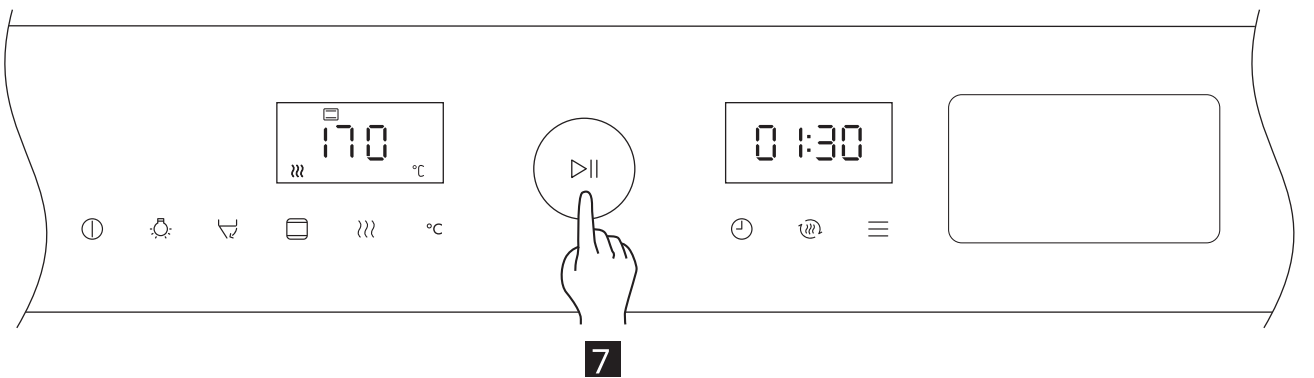
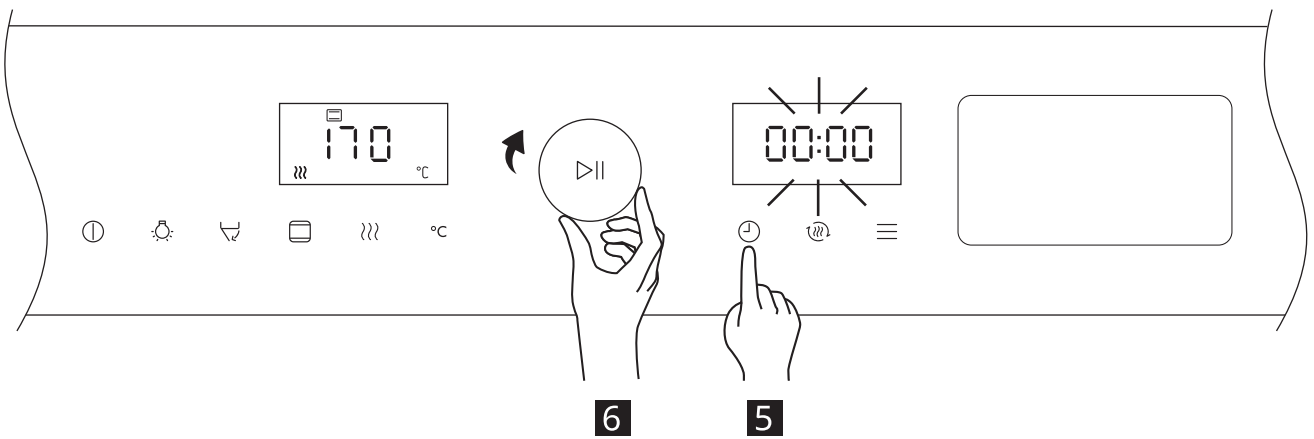
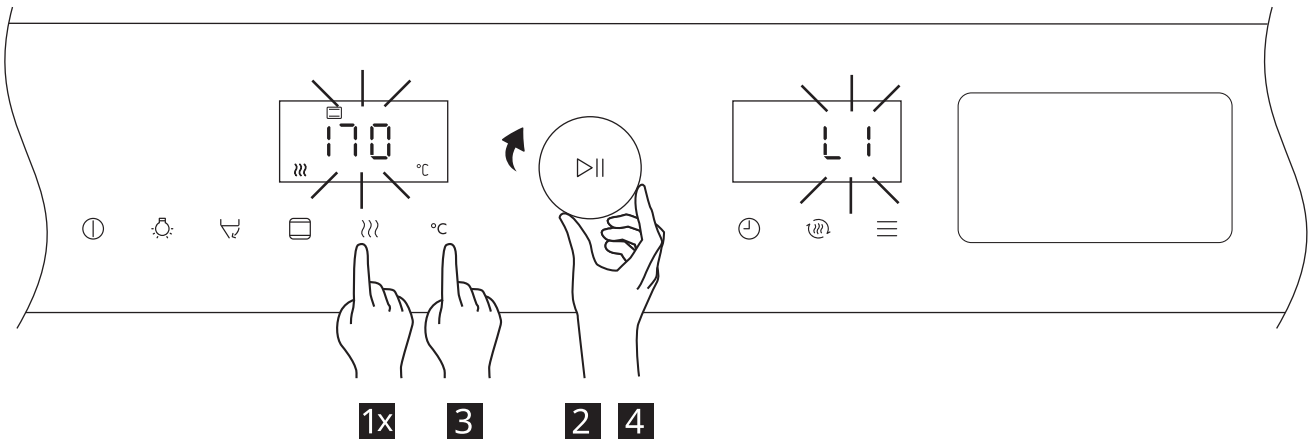
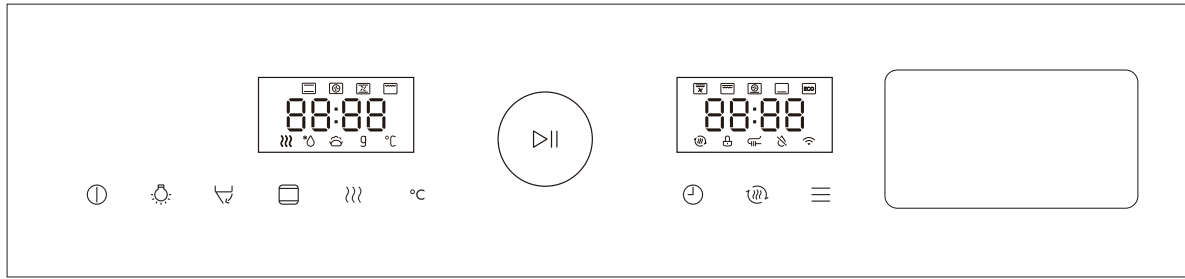

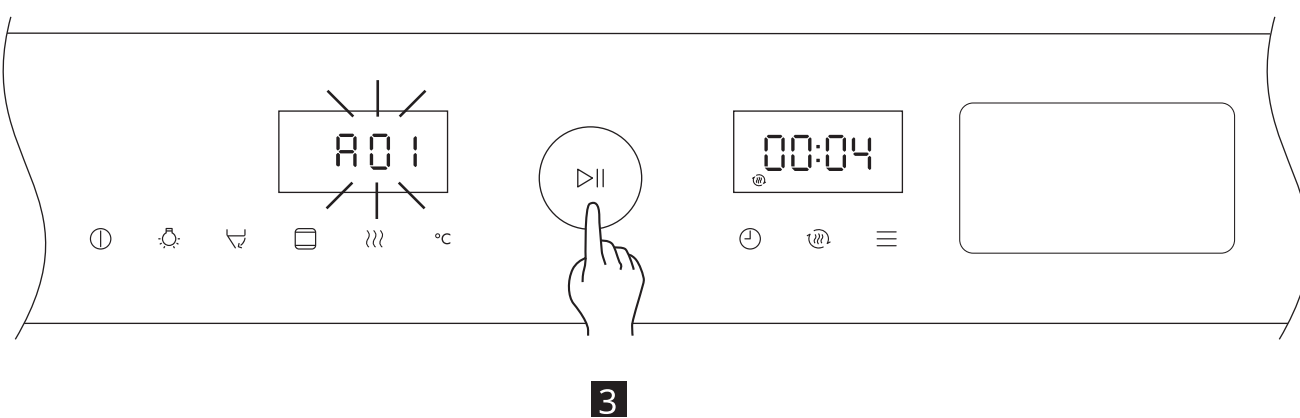
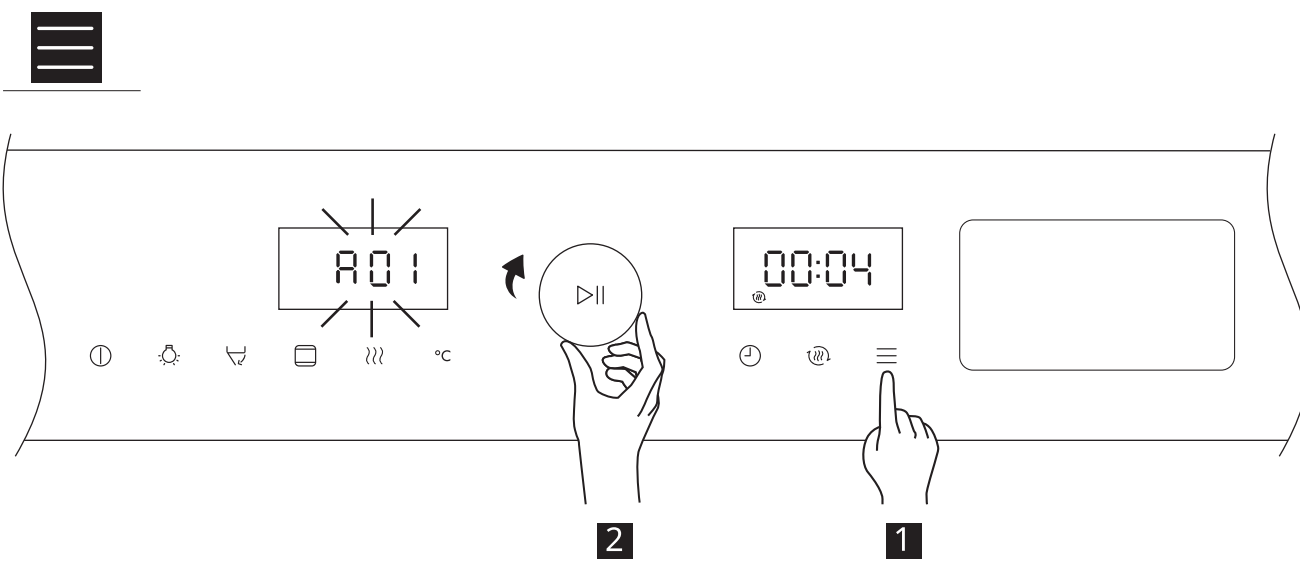
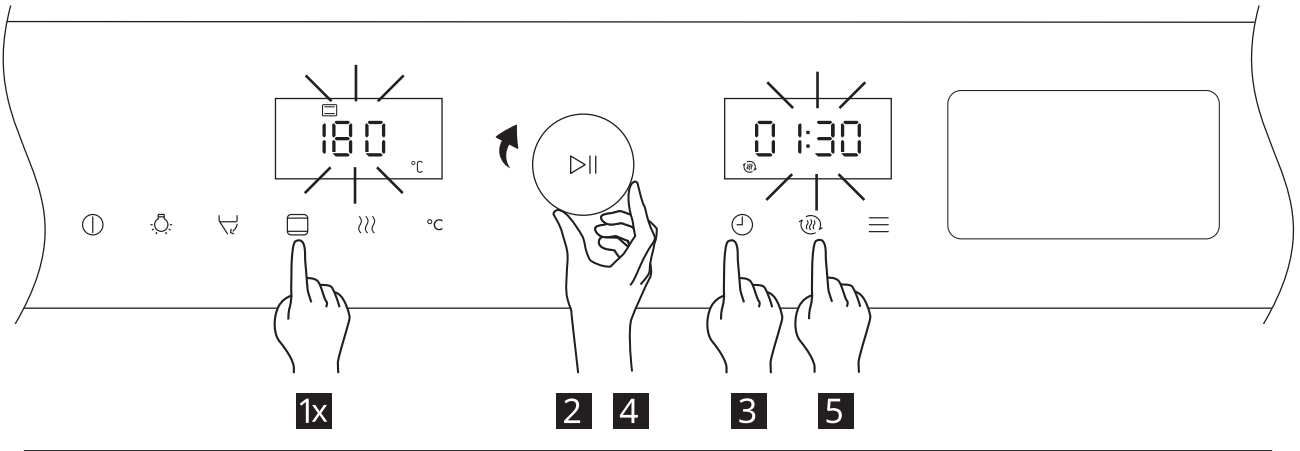
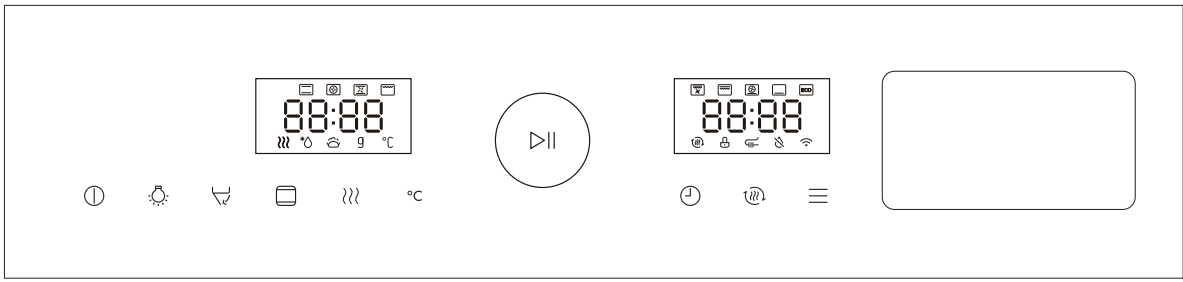



















A	°C	Min
A01	 250°C	4 min
A02	 250°C	8 min
A03	 150°C	50 min
A04	 160°C	35 min
A05	 200°C	50 min
A06	 190°C	22 min
A07	 190°C	24 min
A08	 250°C	8 min
A09	 L1 230°C	25 min
A10	 L1 200°C	25 min
A11	 L1 220°C	14 min
A12	 L1 200°C	45 min
A13	 L1 180°C	50 min
A14	 L1 220°C	25 min
A15	 L1 230°C	80 min
A16	 L1 160°C	55 min
A17	 L1 180°C	25 min
A18	 L1 190°C	30 min

Product description

General overview

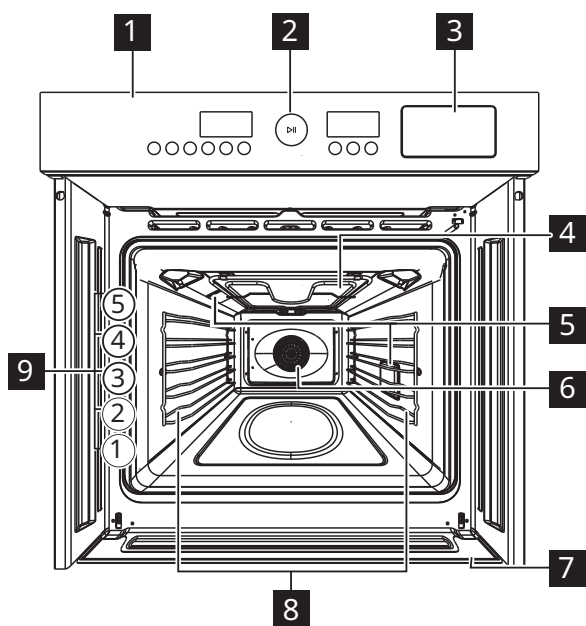

- 1 Control panel
- 2 Knob for setting
- 3 Water drawer
- 4 Grill
- 5 Lamp
- 6 Fan
- 7 Water collector
- 8 Shelf support, removable
- 9 Shelf positions

Control panel

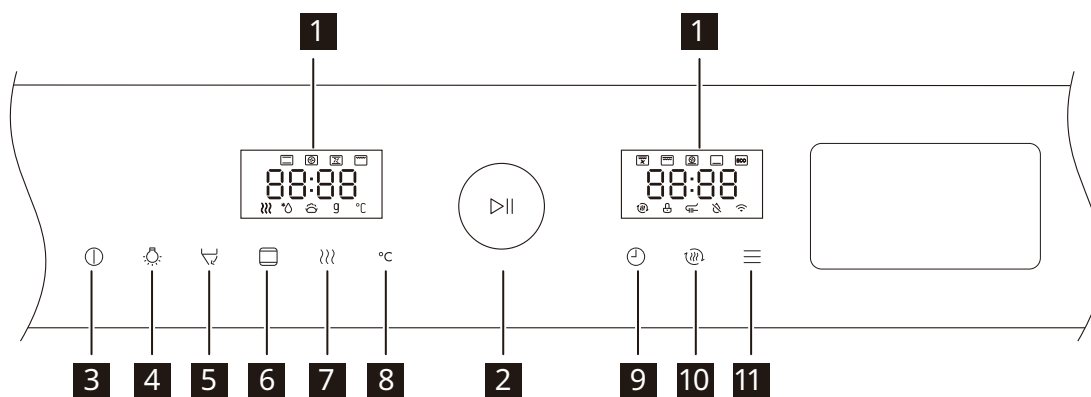

- 1 Display
- 2 Knob
- 3 Cancel
- 4 Lamp
- 5 Water box
- 6 Mode selection
- 7 Steam
- 8 Temperature
- 9 Time
- 10 Rapid preheating
- 11 Auto menu

Display

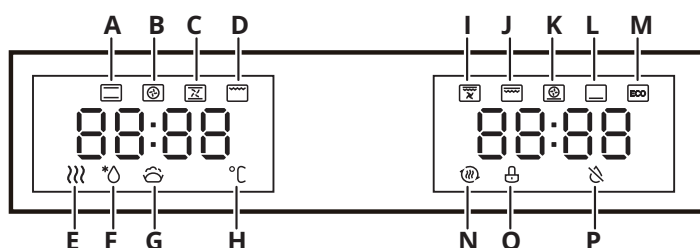

- | | |
|-----------------------|------------------|
| A. Conventional | J. Double grill |
| B. Convection | K. Pizza |
| C. Conventional+fan | L. Bottom heat |
| D. Grill | M. ECO |
| E. Steam | N. Quick preheat |
| F. Defrost | O. Child proof |
| G. Dough proofing | P. Lack of water |
| H. Temperature | |
| I. Double grill + fan | |

The menus in overview

- | | | |
|--|---------------------------|---|
| | Conventional | Baked large cakes. |
| | Convection | Especially suitable for baking food that needs to be evenly colored. |
| | Conventional + fan | The combination of fans and heating elements provides more uniform heat penetration, saving up to 30-40% of energy. |
| | Grill | Bake small amounts of food. |
| | Double grill + fan | Barbecue flat food. |
| | Double grill | Bake small amounts of flat food. |
| | Pizza | Baked pizza. |
| | Bottom heat | Color the bottoms of flat foods. |
| | ECO | For energy-saved cooking. |
| | Defrost | Defrost frozen food. |
| | Dough proofing | Fermented dough or yogurt. |
| | Drying function | It is used to dry the furnace chamber and prevent bacteria from growing. |
| | Descaling | By adding citric acid to water box, to remove scale in the pipe. |

Cooking mode with Steam assist function

- | | | | | | |
|--|---------------------|--|--------------------|--|-------------------------|
| | Conventional | | Grill | | Conventional+fan |
| | Convection | | Bottom heat | | Steam cleaning |

Water box of use

When putting the water box back into the tank seat, make sure that the water tank is pushed all the way.

After cooking, discard any remaining water in the water box and wipe dry to prevent bacteria from growing.

When using the steam assist function and the automatic menu, please add purified water to the water tank in advance.

way 1

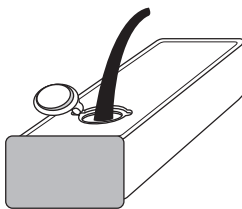

way 2

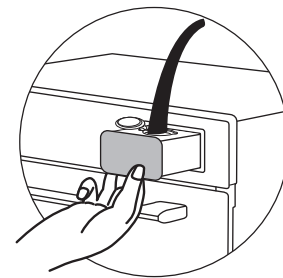

1. Click the "☒" key to take out the entire water box, open the rubber ring and add water.
2. Click the "☒" key to pop out the water box, open the rubber ring and add water.

Troubleshooting

If you encounter an issue with your appliance, check "What to do it..." chapter

in the full version of the User Manual available on: www.ikea.com.

Auto menu sheet

Display	Menu	Mode or Temperature	Time	Preheat
A01	Roasted beef ribs	250°C	4 min	YES
A02	Beef steak with black pepper	250°C	8 min	YES
A03	Chiffon Cake	150°C	50 min	YES
A04	Red velvet cupcake	160°C	35 min	YES
A05	French roast pork chop	200°C	50 min	YES
A06	Italian fruit pie (8 inches)	190°C	22 min	YES
A07	Cream puff	190°C	24 min	YES
A08	Roasted cod	250°C	8 min	YES

A09	Roast chicken wings	 L1 230°C	25 min	YES
A10	Roast pork ribs	 L1 200°C	25 min	NO
A11	Roast saury	 L1 220°C	14 min	YES
A12	Roast whole chicken	 L1 200°C	45 min	YES
A13	Roast pork	 L1 180°C	50 min	YES
A14	French lamb chop	 L1 220°C	25 min	YES
A15	French Roast Pork Knuckle	 L1 230°C	80 min	NO
A16	Cheese cake	 L1 160°C	55 min	YES
A17	Chocolate cranberry bread	 L1 180°C	25 min	YES
A18	Nut bread	 L1 190°C	30 min	YES

Technical data

Technical data

Dimensions (internal)	Width Height Depth	503 mm 353 mm 386 mm
Area of baking tray	1159 cm ²	
Top heating element	900 W	
Bottom heating element	1500 W	
Grill	1300 W	
Ring	1800 W	
Total rating	3150 W	

Technical data

Voltage	220 - 240V~
Frequency	50 - 60 Hz
Number of functions	14

Technical data

Technical data

Dimensions (internal)	Width Height Depth	503 mm 353 mm 386 mm
Area of baking tray	1159 cm ²	
Top heating element	900 W	
Bottom heating element	1500 W	
Grill	1300 W	
Ring	1800 W	
Total rating	3150 W	

Technical data

Voltage	220 - 240V~
Frequency	50 - 60 Hz
Number of functions	14

Energy efficiency

Product Information and Product Information Sheet*

Supplier's name	IKEA
Model identification	MÅGEBO 905-570-61
Energy Efficiency Index	76.9
Energy efficiency class	A+
Energy consumption with a standard load, conventional mode	1.02kWh
Energy consumption with a standard load, fan-forced mode	0.65kWh
Number of cavities	1
Heat source	Electricity
Volume	72 l
Type of oven	Built-In Oven
Mass	43.5 kg
* For European Union according to EU Regulations 65/2014 and 66/2014. For Republic of Belarus according to STB 2478-2017, Appendix G; STB 2477-2017, Annexes A and B.	
Energy efficiency class is not applicable for Russia.	
EN 60350-1 - Household electric cooking appliances - Part 1: Ranges, ovens, steam ovens and grills - Methods for measuring performance.	

Produktbeschreibung

Allgemeine Übersicht

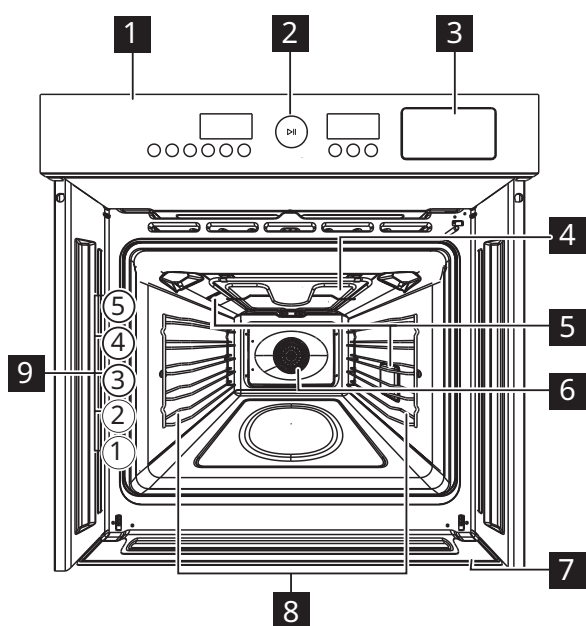

- 1 Bedienfeld
- 2 Einstelltaste
- 3 Wasserbehälter
- 4 Grill
- 5 Garraumbeleuchtung
- 6 Lüfter
- 7 Wasserauffangbehälter
- 8 Herausnehmbare Einschubführungen
- 9 Einschubpositionen

Bedienfeld

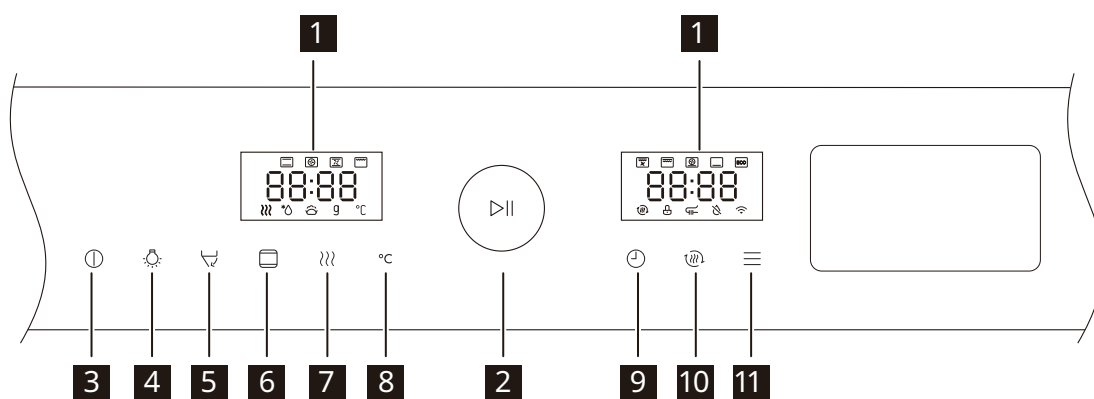

- 1 Display
- 2 Drehknopf
- 3 Abbrechen
- 4 Garraumbeleuchtung
- 5 Wasserbehälter
- 6 Modusauswahl
- 7 Dampf
- 8 Temperatur
- 9 Zeit
- 10 Schnelles Vorwärmen
- 11 Automatisches Menü

Display

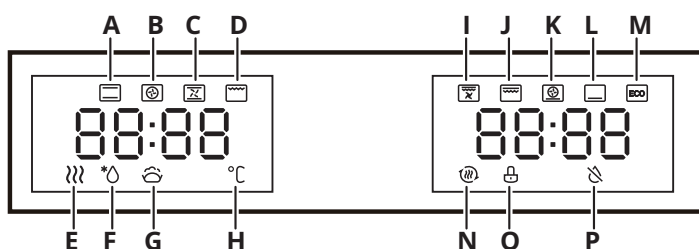

- | | |
|---------------------------|------------------------|
| A. Herkömmlich | J. Zweifachgrill |
| B. Umluft | K. Pizza |
| C. Herkömmlich + Lüfter | L. Unterhitze |
| D. Grill | M. ÖKO |
| E. Dampf | N. Schnelles Vorwärmen |
| F. Auftauen | O. Kindersicherung |
| G. Teig | P. Wasser unzureichend |
| H. Temperatur | |
| I. Zweifachgrill + Lüfter | |

Übersicht über die Programme

- | | | |
|--|-------------------------------|--|
| | Herkömmlich | Große Kuchen backen. |
| | Umluft | Dieser Modus eignet sich auch für Backwaren, die eine gleichmäßige Bräunung benötigen. |
| | Herkömmlich + Lüfter | Die Kombination der Heizelemente mit dem Lüfter ermöglicht eine gleichmäßigere Wärmeverteilung und spart dadurch bis zu 30 – 40 % Energie. |
| | Grill | Ideal fürs Backen kleiner Mengen an Backwaren. |
| | Zweifachgrill + Lüfter | Flaches BBQ-Grillgut. |
| | Zweifachgrill | Ideal für das Backen kleiner Mengen von flachen Backwaren. |
| | Pizza | Gebackene Pizza. |
| | Unterhitze | Bräunen der Unterseite flacher Nahrungsmittel. |
| | ÖKO | Für energiesparendes Backen. |
| | Auftauen | Auftauen gefrorener Nahrungsmittel. |
| | Teig | Teig gehen oder Joghurt gären lassen. |
| | Trocknerfunktion | Zum Trocken des Ofengarraums, um einem Wachstum von Bakterien vorzubeugen. |
| | Entkalken | Für die Entfernung von Kalkablagerungen in den Leitungen geben Sie etwas Wasser mit Zitronensäure in den Wasserbehälter. |

Garmodi mit Dampfunterstützung

- | | | | | | |
|--|--------------------|--|-------------------|--|-----------------------------|
| | Herkömmlich | | Grill | | Herkömmlich + Lüfter |
| | Umluft | | Unterhitze | | Dampfreinigung |

Besuchen Sie für das Herunterladen der vollständigen Bedienungsanleitung www.ikea.com

Den Wasserbehälter benutzen

Achten Sie beim Wiedereinsetzen des Wasserbehälters darauf, dass er vollständig hineingeschoben ist.

Um einem Bakterienwachstum vorzubeugen, entleeren Sie den Wasserbehälter nach Abschluss der Zubereitung und wischen ihn anschließend trocken.

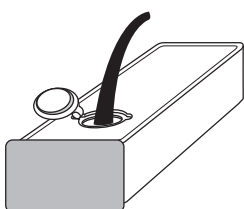

Für die Benutzung der Dampffunktion und der Automatikprogramme füllen Sie bitte nur gereinigtes Wasser in den Wasserbehälter.

Methode 1

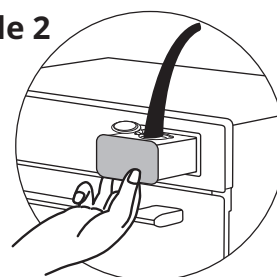

Methode 2









1. Zum Entnehmen des ganzen Wasserbehälters drücken Sie die -Taste. Entfernen Sie den Gummistopfen und füllen Sie anschließend Wasser ein.
2. Um nur einen Teil des Wasserbehälters herausfließen zu lassen, drücken Sie die -Taste. Entfernen Sie den Gummistopfen und füllen Sie anschließend Wasser ein.

Problembehebung





Bei Problemen mit Ihrem Gerät lesen Sie das Kapitel „Was tun, wenn...“ in der ausführlichen Version des

Benutzerhandbuchs, auf das Sie unter www.ikea.com zugreifen können.

Die Automatikprogramme

Display	Menü	Modus oder Temperatur	Zeit	Vorwärmen
A01	Gebratene Rinderrippen	 250 °C	4 min	JA
A02	Rindersteak mit schwarzem Pfeffer	 250 °C	8 min	JA
A03	Chiffon-Kuchen	 150 °C	50 min	JA
A04	Rote Samt-Cupcakes	 160 °C	35 min	JA
A05	Französisches Schweinekotelett	 200 °C	50 min	JA
A06	Italienischer Obstkuchen (20 cm)	 190 °C	22 min	JA
A07	Windbeutel	 190 °C	24 min	JA

Besuchen Sie für das Herunterladen der vollständigen Bedienungsanleitung www.ikea.com

A08	Gebratener Kabeljau	 250 °C	8 min	JA
A09	Gebratene Hähnchenflügel	 L1 230 °C	25 min	JA
A10	Gebratene Schweinerippchen	 L1 200 °C	25 min	NEIN
A11	Gebratene Makrele	 L1 220 °C	14 min	JA
A12	Ganzes Brathähnchen	 L1 200 °C	45 min	JA
A13	Schweinebraten	 L1 180 °C	50 min	JA
A14	Französisches Lammkotelett	 L1 220 °C	25 min	JA
A15	Gebratene Schweinehaxe französisch	 L1 230 °C	80 min	NEIN
A16	Käsekuchen	 L1 160 °C	55 min	JA
A17	Schokoladen-Preiselbeer-Brot	 L1 180 °C	25 min	JA
A18	Nussbrot	 L1 190 °C	30 min	JA

Technische Daten

Technische Daten

Abmessungen (innen)	Breite Höhe Tiefe	503 mm 353 mm 386 mm
Backblechfläche	1159 cm ²	
Oberes Heizelement	900 W	
Unteres Heizelement	1500 W	
Grill	1300 W	
Ring	1800 W	
Gesamtnennleistung	3150 W	

Technische Daten

Spannung	220 - 240 V~
Frequenz	50 - 60 Hz
Anzahl der Funktionen	14

Technische Daten

Technische Daten

Abmessungen (innen)	Breite Höhe Tiefe	503 mm 353 mm 386 mm
Backblechfläche	1159 cm ²	
Oberes Heizelement	900 W	
Unteres Heizelement	1500 W	
Grill	1300 W	
Ring	1800 W	
Gesamtnennleistung	3150 W	

Technische Daten

Spannung	220 - 240 V~
Frequenz	50 - 60 Hz
Anzahl der Funktionen	14

Energieeffizienz

Produktinformation und -informationsblatt*

Name des Anbieters	IKEA
Modellbezeichnung	MÅGEBO 905-570-61
Energieeffizienzindex	76,9
Energieeffizienzklasse	A+
Energieverbrauch mit Standardlast im konventionellen Modus	1,02 kWh
Energieverbrauch mit Standardlast bei laufendem Lüfter	0,65 kWh
Anzahl der Garräume	1
Wärmequelle	Elektrizität
Volumen	72 l
Ofentyp	Einbauofen
Gewicht	43,5 kg
* Für die Europäische Union gemäß den EU-Verordnungen 65/2014 und 66/2014. Für die Republik Belarus gemäß STB 2478-2017, Anhang G; STB 2477-2017 Anhänge A und B.	
Die Energieeffizienzklasse gilt nicht für Russland.	
EN 60350-1 – Elektrische Kochgeräte für den Hausgebrauch – Teil 1: Herde, Backöfen, Dampfgarer und Grills – Verfahren zur Messung der Gebrauchseigenschaften.	

Description de l'appareil

Présentation générale

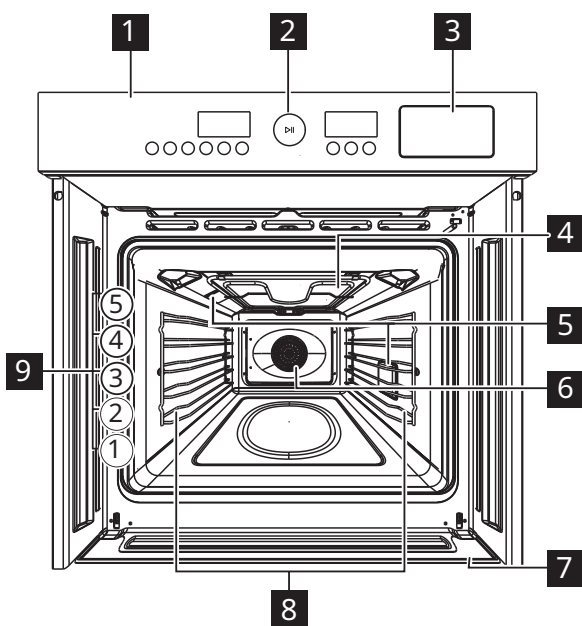

- 1 Bandeau de commande
- 2 Bouton de réglage
- 3 Bac d'égouttage
- 4 Gril
- 5 Lampe
- 6 Ventilateur
- 7 Récupérateur d'eau
- 8 Support de plateau amovible
- 9 Positionnement des plateaux

Bandeau de commande

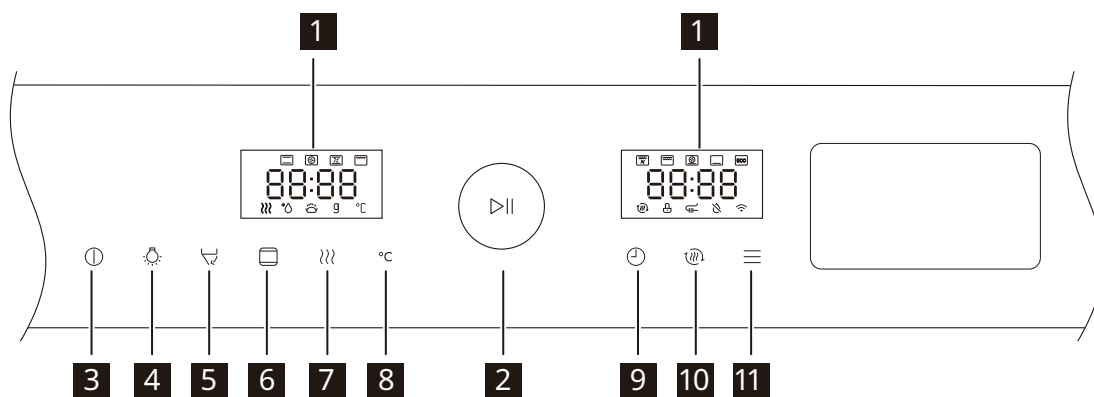

- 1 Écran
- 2 Molette
- 3 Annulation
- 4 Lampe
- 5 Caisson à eau
- 6 Sélection du mode
- 7 Vapeur
- 8 Température
- 9 Temps
- 10 Préchauffage rapide
- 11 Menu automatique

Écran

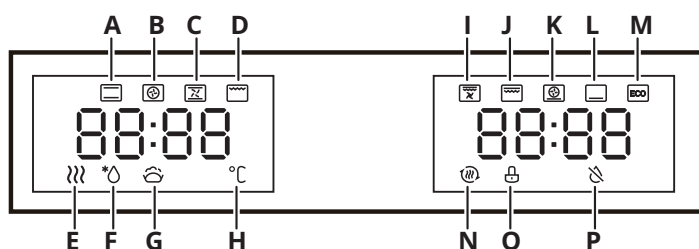

- | | |
|--------------------------------|---------------------------------|
| A. Conventionnel | I. Gril double +
Ventilation |
| B. Convection | J. Gril double |
| C. Convection +
Ventilation | K. Pizza |
| D. Gril | L. Chaleur de fond |
| E. Vapeur | M. ÉCO |
| F. Décongélation | N. Préchauffage
rapide |
| G. Vérification de
la pâte | O. Sécurité enfants |
| H. Température | P. Manque d'eau |

Vue d'ensemble des menus

- | | | |
|--|--|---|
| | Conventionnel | Permet de cuire des gâteaux de grande taille. |
| | Convection | Il est particulièrement adapté à la cuisson des aliments qui doivent avoir une couleur uniforme. |
| | Conventionnel +
Ventilation | La combinaison des ventilateurs et des éléments chauffants favorise une pénétration plus uniforme de la chaleur, ce qui permet d'économiser de 30 à 40 % d'énergie. |
| | Grill | Permet de cuire de petites quantités d'aliments. |
| | Gril double +
Ventilation | Nourriture plate pour barbecue. |
| | Gril double | Permet de petites quantités d'aliments plats. |
| | Pizza | Pizza au four. |
| | Chaleur de fond | Permet de donner une couleur à la partie inférieure des aliments plats. |
| | ÉCO | Pour une cuisson économe en énergie. |
| | Décongélation | Permet de décongeler les aliments congelés. |
| | Vérification de
la pâte | Pâte fermentée ou yaourt.
Il est utilisé pour sécher la chambre du four et empêcher le développement des bactéries. |
| | Fonction de
séchage | Ajoutez de l'acide citrique au caisson à eau pour enlever le tartre du tuyau. |
| | Détartrage | |

Mode de cuisson avec fonction d'assistance vapeur

- | | | | | | |
|--|----------------------|--|------------------------|--|------------------------------------|
| | Conventionnel | | Grill | | Conventionnel + Ventilation |
| | Convection | | Chaleur de fond | | Nettoyage à la vapeur |

Utilisation du caisson à eau

Lorsque vous remettez le caisson à eau dans le siège du réservoir, assurez-vous que celui-ci est poussé à fond.

Après la cuisson, jetez toute l'eau qui reste dans le caisson à eau et essuyez-le pour empêcher le développement des bactéries.

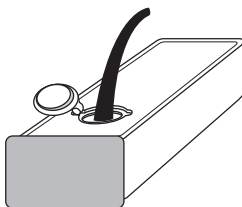

Lorsque vous utilisez la fonction d'assistance vapeur et le menu de cuisson automatique, ajoutez de l'eau purifiée au réservoir d'eau à l'avance.

1^{re} option

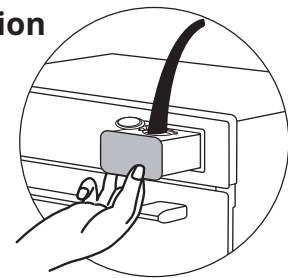

2^e option





















1. Appuyez sur la touche «  » pour sortir entièrement le caisson à eau, ouvrez l'anneau en caoutchouc et ajoutez de l'eau.
2. Appuyez sur la touche «  » pour faire sortir partiellement le caisson à eau, ouvrez l'anneau en caoutchouc et ajoutez de l'eau.

Dépannage

Si vous rencontrez un problème avec votre appareil, consultez le chapitre « Que faire si... ? » dans la version complète du manuel disponible à l'adresse : www.ikea.com.

Fiche du menu de cuisson automatique

Écran	Menu	Mode ou température	Temps	Préchauffage
A01	Côtes de bœuf rôties	 250 °C	4 min	OUI
A02	Steak de bœuf au poivre noir	 250 °C	8 min	OUI
A03	Gâteau mousseline	 150 °C	50 min	OUI
A04	Petits gâteaux Red Velvet	 160 °C	35 min	OUI
A05	Côtelette de porc rôtie à la française	 200 °C	50 min	OUI
A06	Tarte aux fruits italienne (20,3 cm)	 190 °C	22 min	OUI
A07	Chou à la crème	 190 °C	24 min	OUI

A08	Morue rôtie	 250 °C	8 min	OUI
A09	Ailes de poulet rôties	 L1 230 °C	25 min	OUI
A10	Côtes de porc rôties	 L1 200 °C	25 min	NON
A11	Balaou rôti	 L1 220 °C	14 min	OUI
A12	Poulet entier rôti	 L1 200 °C	45 min	OUI
A13	Rôti de porc	 L1 180 °C	50 min	OUI
A14	Côtelette d'agneau à la française	 L1 220 °C	25 min	OUI
A15	Jarret de porc rôti à la française	 L1 230 °C	80 min	NON
A16	Gâteau au fromage	 L1 160 °C	55 min	OUI
A17	Pain au chocolat et aux canneberges	 L1 180 °C	25 min	OUI
A18	Pain aux noix	 L1 190 °C	30 min	OUI

Données techniques

Données techniques

Dimensions (internes)	Largeur Hauteur Profondeur	503 mm 353 mm 386 mm
Zone du plateau de cuisson	1 159 cm ²	
Élément chauffant supérieur	900 W	
Élément chauffant inférieur	1 500 W	
Gril	1 300 W	
Anneau	1 800 W	
Puissance nominale totale	3 150 W	

Données techniques

Tension	220 à 240 V~
Fréquence	50 à 60 Hz
Nombre de fonctions	14

Données techniques

Données techniques

Dimensions (internes)	Largeur	503 mm
	Hauteur	353 mm
	Profondeur	386 mm
Zone du plateau de cuisson	1 159 cm ²	
Élément chauffant supérieur	900 W	
Élément chauffant inférieur	1 500 W	
Gril	1 300 W	
Anneau	1 800 W	
Puissance nominale totale	3 150 W	

Données techniques

Tension	220 à 240 V~
Fréquence	50 à 60 Hz
Nombre de fonctions	14

Efficacité énergétique

Informations sur le produit et fiche d'information produit*

Nom du fournisseur	IKEA
Identification du modèle	MÅGEBO 905-570-61
Indice d'efficacité énergétique	76,9
Classe d'efficacité énergétique	A+
Consommation d'énergie avec une charge standard, mode conventionnel	1,02 kWh
Consommation d'énergie avec une charge standard, mode ventilateur forcé	0,65 kWh
Nombre de chambres de cuisson	1
Source de chaleur	Électricité
Volume	72 l
Type de four	Four encastrable
Masse	43,5 kg
<p>* Pour l'Union européenne conformément aux règlements européens 65/2014 et 66/2014. Pour la République du Bélarus, conformément à STB 2478-2017, annexe G et STB 2477-2017, annexes A et B.</p>	
<p>La classe d'efficacité énergétique ne s'applique pas à la Russie.</p>	
<p>EN 60350-1 — Appareils électroménagers de cuisson — Partie 1 : Cuisinières, fours, fours à vapeur et grils — Méthodes de mesure des performances.</p>	

Descrizione del prodotto

Panoramica generale

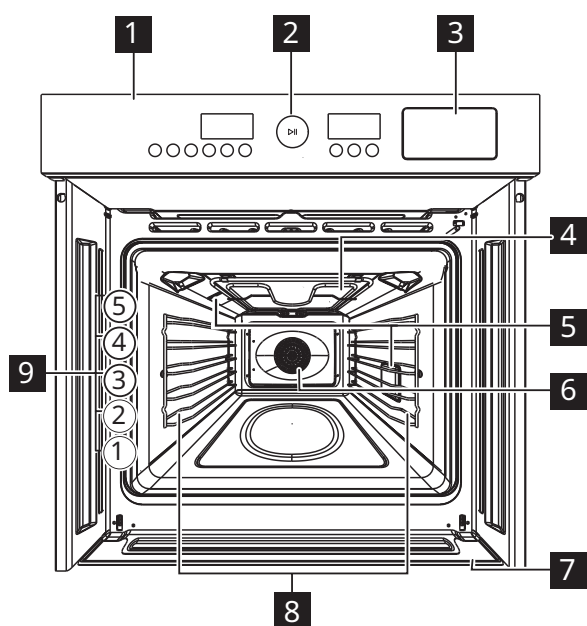

- 1** Pannello di controllo
- 2** Manopola di impostazione
- 3** Cassetto dell'acqua
- 4** Griglia
- 5** Lampada
- 6** Ventola
- 7** Collettore dell'acqua
- 8** Supporto per ripiano, removibile
- 9** Posizioni del ripiano

Pannello di controllo

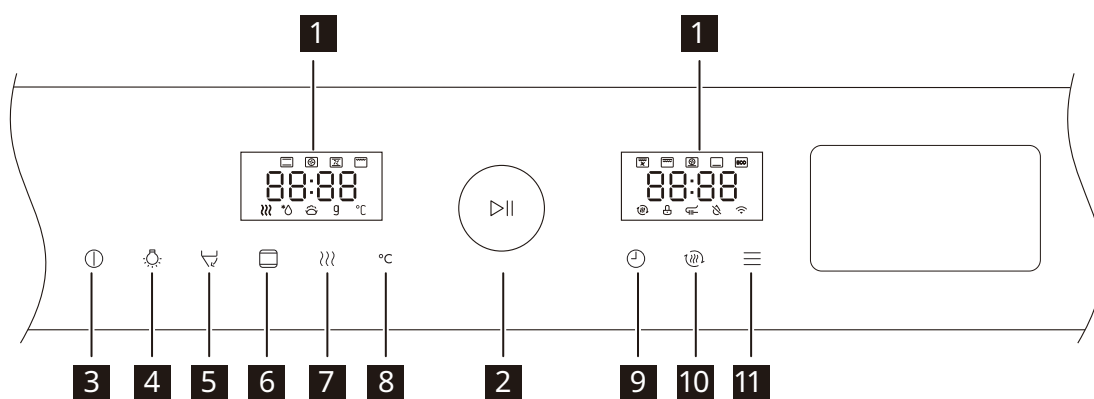

- 1** Display
- 2** Manopola
- 3** Annulla
- 4** Lampada
- 5** Contenitore dell'acqua
- 6** Selezione della modalità
- 7** Vapore
- 8** Temperatura
- 9** Ora
- 10** Preriscaldamento rapido
- 11** Menu automatico

Display

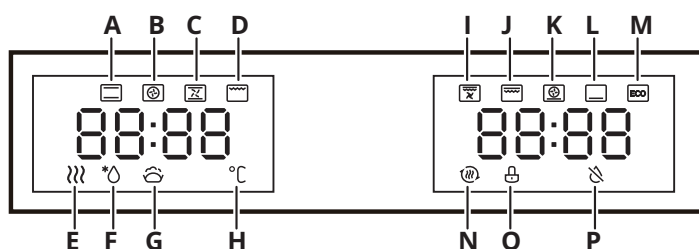

- | | |
|------------------------------|-------------------------------|
| A. Convenzionale | I. Doppia griglia + ventilato |
| B. Forno a convezione | J. Doppia griglia |
| C. Convenzionale + ventilato | K. Pizza |
| D. Griglia | L. Calore in basso |
| E. Vapore | M. ECO |
| F. Sbrinamento | N. Preriscaldamento rapido |
| G. Lievitazione | O. Sicurezza bambini |
| H. Temperatura | P. Mancanza d'acqua |

I menu in sintesi

- | | | |
|--|-----------------------------------|--|
| | Convenzionale | Adatto per cuocere torte di grandi dimensioni. |
| | Forno a convezione | Particolarmente indicato per la cottura di alimenti che devono risultare dorati in modo uniforme. |
| | Convenzionale + ventilato | La combinazione di ventole ed elementi riscaldanti garantisce un'azione più uniforme del calore, con un risparmio energetico fino al 30-40%. |
| | Funzione Grill | Ideale per cuocere piccole quantità di cibo. |
| | Doppia griglia + ventilato | Cottura al barbecue di piatti pronti. |
| | Doppia griglia | Ideale per cuocere piccole quantità di piatti pronti. |
| | Pizza | Pizza al forno. |
| | Calore in basso | Ideale per dorare anche la parte inferiore dei piatti pronti. |
| | ECO | Per una cottura a risparmio energetico. |
| | Sbrinamento | Scongelamento alimenti surgelati. |
| | Lievitazione | Pasta fermentata o yogurt. |
| | Funzione di asciugatura | Viene utilizzato per asciugare la camera del forno e impedire la crescita dei batteri. |
| | Decalcificazione | Aggiungendo acido citrico nel contenitore dell'acqua, è possibile rimuovere le incrostazioni nel tubo. |

Modalità di cottura al vapore

- | | | | | | |
|--|---------------------------|--|------------------------|--|----------------------------------|
| | Convenzionale | | Funzione Grill | | Convenzionale + ventilato |
| | Forno a convezione | | Calore in basso | | Pulizia a vapore |

Utilizzo del contenitore dell'acqua

Quando si rimette il contenitore dell'acqua nella sede del serbatoio, assicurarsi che il serbatoio dell'acqua venga spinto fino in fondo.

Dopo la cottura, gettare l'acqua residua nel contenitore dell'acqua e asciugare bene, per evitare la formazione di batteri.

Quando si utilizza la funzione di cottura al vapore e il menu automatico, aggiungere preventivamente acqua depurata nel serbatoio dell'acqua.

Modalità 1

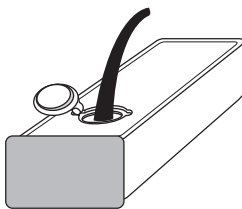

Modalità 2

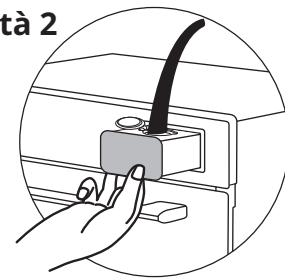

1. Fare clic sul tasto "☒" per estrarre completamente il contenitore dell'acqua, quindi aprire l'anello di gomma e aggiungere acqua.
2. Fare clic sul tasto "☒" per estrarre il contenitore dell'acqua, quindi aprire l'anello di gomma e aggiungere acqua.

Risoluzione dei problemi

Se si riscontra un problema con l'apparecchio, consultare il capitolo "Cosa fare..." nella versione completa del

manuale dell'utente disponibile sul sito: www.ikea.com.

Scheda menu automatico

Display	Menu	Modalità o temperatura	Ora	Preriscaldamento
A01	Costine di manzo arrosto	☒ 250 °C	4 min	Sì
A02	Bistecca di manzo al pepe nero	☒ 250 °C	8 min	Sì
A03	Chiffon Cake	☒ 150 °C	50 min	Sì
A04	Cupcake red velvet	☒ 160 °C	35 min	Sì
A05	Costoletta di maiale arrosto alla francese	☒ 200 °C	50 min	Sì
A06	Torta di frutta all'italiana (8 pollici)	☒ 190 °C	22 min	Sì
A07	Bignè alla crema	☒ 190 °C	24 min	Sì

A08	Merluzzo arrosto	 250 °C	8 min	Sì
A09	Ali di pollo arrosto	 L1 230 °C	25 min	Sì
A10	Costine di maiale arrosto	 L1 200 °C	25 min	NO
A11	Costardelle arrosto	 L1 220 °C	14 min	Sì
A12	Pollo intero arrosto	 L1 200 °C	45 min	Sì
A13	Maiale arrosto	 L1 180 °C	50 min	Sì
A14	Costoletta d'agnello alla francese	 L1 220 °C	25 min	Sì
A15	Stinco di maiale arrosto alla francese	 L1 230 °C	80 min	NO
A16	Cheesecake	 L1 160 °C	55 min	Sì
A17	Pane al cioccolato e mirtilli rossi	 L1 180 °C	25 min	Sì
A18	Pane alle noci	 L1 190 °C	30 min	Sì

Dati tecnici

Dati tecnici

Dimensioni (interne)	Larghezza Altezza Profondità	503 mm 353 mm 386 mm
Area della teglia da forno	1159 cm ²	
Elemento riscaldante superiore	900 W	
Elemento riscaldante inferiore	1500 W	
Griglia	1300 W	
Anello	1800 W	
Potenza nominale totale	3150 W	

Dati tecnici

Tensione	220 - 240 V ~
Frequenza	50 - 60 Hz
Numero di funzioni	14

Dati tecnici**Dati tecnici**

Dimensioni (interne)	Larghezza	503 mm
	Altezza	353 mm
	Profondità	386 mm
Area della teglia da forno	1159 cm ²	
Elemento riscaldante superiore	900 W	
Elemento riscaldante inferiore	1500 W	
Griglia	1300 W	
Anello	1800 W	
Potenza nominale totale	3150 W	

Dati tecnici

Tensione	220 - 240 V ~
Frequenza	50 - 60 Hz
Numero di funzioni	14

Efficienza energetica

Informazioni sul prodotto e scheda informativa del prodotto*

Nome del fornitore	IKEA
Identificazione del modello	MÅGEBO 905-570-61
Indice di efficienza energetica	76,9
Classe di efficienza energetica	A+
Consumo di energia con un carico standard, modalità convenzionale	1,02 kWh
Consumo di energia con un carico standard, modalità forno ventilato	0,65 kWh
Numero di camere del forno	1
Fonte di calore	Elettricità
Volume	72 l
Tipo di forno	Forno a incasso
Massa	43,5 kg
* Per l'Unione Europea, secondo i Regolamenti UE 65/2014 e 66/2014. Per la Repubblica di Bielorussia, secondo STB 2478-2017, Appendice G; STB 2477-2017, Allegati A e B.	
La classe di efficienza energetica non è applicabile alla Russia.	
EN 60350-1 - Apparecchi di cottura elettrici per uso domestico - Parte 1: Caminetti, forni, forni a vapore e griglie - Metodi di misurazione delle prestazioni.	

Beskrivelse af produktet

Generel oversigt

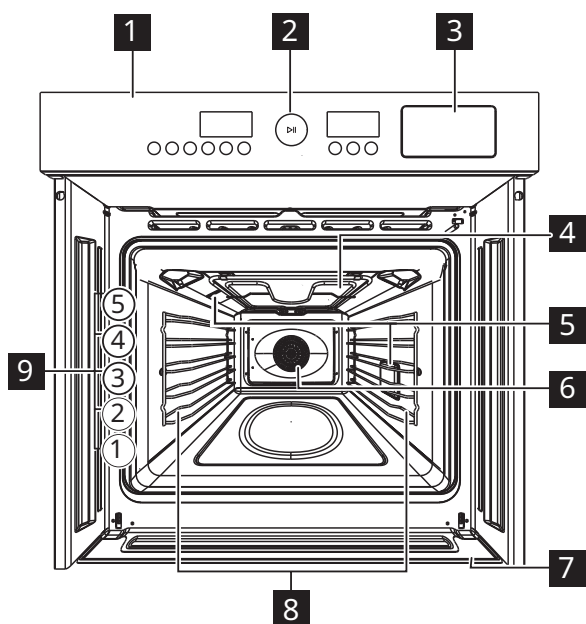

- 1 Kontrolpanel
- 2 Indstillingsknop
- 3 Vandskuffe
- 4 Grill
- 5 Lys
- 6 Blæser
- 7 Vandopsamler
- 8 Hyldestøtte, aftagelig
- 9 Hyldepositioner

Kontrolpanel

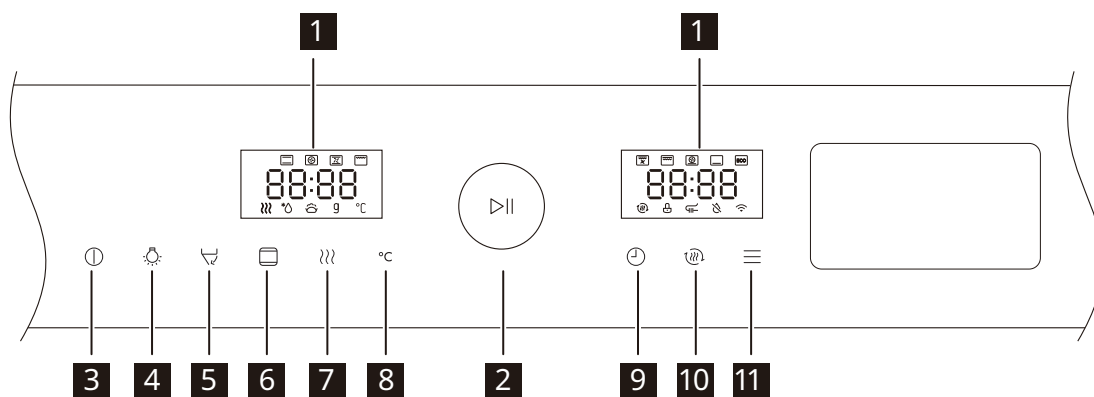

- 1 Display
- 2 Drejeknap
- 3 Annullér
- 4 Lys
- 5 Vandskuffe
- 6 Valg af tilstand
- 7 Damp
- 8 Temperatur
- 9 Tid
- 10 Hurtig forvarmning
- 11 Automenu

Display

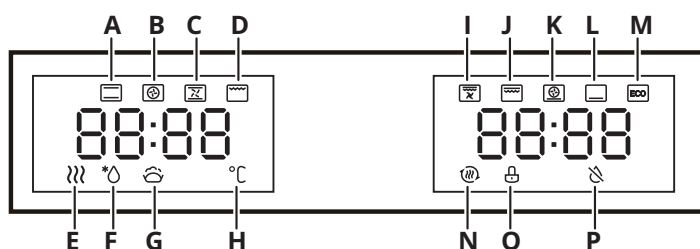

- | | |
|--------------------------|--------------------------|
| A. Konventionel | I. Dobbeltgrill + blæser |
| B. Konvektion | J. Dobbeltgrill |
| C. Konventionel + blæser | K. Pizza |
| D. Grill | L. Bundvarme |
| E. Damp | M. ØKO |
| F. Optøning | N. Hurtig forvarmning |
| G. Hævning af dej | O. Børnelås |
| H. Temperatur | P. Påfyld vand |

Overblik over menuer

- | | | |
|--|------------------------------|---|
| | Konventionel | Stort bagværk. |
| | Konvektion | Tilstanden er specielt egnet til tilberedning af mad, der skal have en ensartet farve. |
| | Konventionel + blæser | Kombinationen af blæser og varmeelementer giver en mere ensartet varmeeffekt, og der spares 30-40 % energi. |
| | Grill | Til tilberedning af små mængder mad. |
| | Dobbeltgrill + blæser | Til tilberedning af flad barbecuemad. |
| | Dobbeltgrill | Til tilberedning af små mængder flad mad. |
| | Pizza | Til bagning af pizza. |
| | Bundvarme | Til brunning af undersiden af flad mad. |
| | ØKO | Til energibesparende tilberedning. |
| | Optøning | Til optøning af frosne madvarer. |
| | Hævning af dej | Til gærdej eller yoghurt. |
| | Tørrefunktion | Funktionen bruges til at tørre ovnrummet og forhindre bakterievækst. |
| | Afkalkning | Hæld citronsyre til vandbeholderen for at fjerne kalk i rørene. |

Tilstand for tilberedning med damp

- | | | | | | |
|--|---------------------|--|------------------|--|------------------------------|
| | Konventionel | | Grill | | Konventionel + blæser |
| | Konvektion | | Bundvarme | | Rengøring med damp |

Brug af vandbeholder

Sørg for, at vandbeholderen er skubbet helt i bund, når du sætter vandbeholderen tilbage i holderen til vandbeholderen.

Tøm vandbeholderen for eventuelt restvand efter tilberedningen, og tør vandbeholderen for at forhindre bakterievækst.

Hæld oprenset vand på vandbeholderen, før du bruger funktionen til tilberedning med damp og den automatiske menu.

måde 1

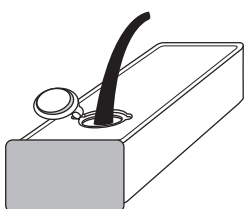

måde 2

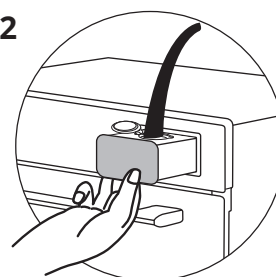

1. Tryk på tasten "☑" for at tage hele vandbeholderen ud, åbn gummiringen, og hæld vand på.
2. Tryk på tasten "☑" for at få vandbeholderen til at springe op, åbn gummiringen, og hæld vand på.











Fejlfinding

Hvis du oplever et problem med dit apparat, skal du læse kapitlet "Hvad gør

jeg, hvis ..." i den komplette version af brugervejledningen på www.ikea.com.

Oversigt over automenu

Display	Menu	Tilstand eller temperatur	Tid	Forvarmning
A01	Grillede okseribben	250 °C	4 min.	JA
A02	Oksebøf med sort peber	250 °C	8 min.	JA
A03	Chiffonkage	150 °C	50 min.	JA
A04	Red velvet cupcakes	160 °C	35 min.	JA
A05	Stegte svinekoteletter	200 °C	50 min.	JA
A06	Italiensk frugtterne (20 cm)	190 °C	22 min.	JA
A07	Flødeboller	190 °C	24 min.	JA

A08	Stegt torsk	 250 °C	8 min.	JA
A09	Stegte kyllingevinger	 L1, 230 °C	25 min.	JA
A10	Stegte svineribben	 L1, 200 °C	25 min.	NEJ
A11	Stegt makrel	 L1, 220 °C	14 min.	JA
A12	Stegt hel kylling	 L1, 200 °C	45 min.	JA
A13	Flæskesteg	 L1, 180 °C	50 min.	JA
A14	Franske lammekoteletter	 L1, 220 °C	25 min.	JA
A15	Stegt svineskank	 L1, 230 °C	80 min.	NEJ
A16	Ostekage	 L1, 160 °C	55 min.	JA
A17	Tranebærbrød med chokolade	 L1, 180 °C	25 min.	JA
A18	Nøddebrød	 L1, 190 °C	30 min.	JA

Tekniske data

Tekniske data

Mål (indvendig)	Bredde Højde Dybde	503 mm 353 mm 386 mm
Bagepladeareal	1,159 cm ²	
Øverste varmeelement	900 W	
Nederste varmeelement	1,500 W	
Grill	1,300 W	
Ring	1,800 W	
Effekt i alt	3,150 W	

Tekniske data

Spænding	220-240 V
Frekvens	50-60 Hz
Antal funktioner	14

Tekniske data**Tekniske data**

Mål (indvendig)	Bredde Højde Dybde	503 mm 353 mm 386 mm
Bagepladeareal	1,159 cm ²	
Øverste varmeelement	900 W	
Nederste varmeelement	1,500 W	
Grill	1,300 W	
Ring	1,800 W	
Effekt i alt	3,150 W	

Tekniske data

Spænding	220-240 V
Frekvens	50-60 Hz
Antal funktioner	14

Energieffektivitet

Produktoplysninger og ark med produktoplysninger*

Leverandørens navn	IKEA
Modelidentifikation	MÅGEBØ 905-570-61
Indeks for energieffektivitet	76,9
Energiklasse	A+
Energiforbrug med standardmængde, konventionel tilstand	1,02 kWh
Energiforbrug med standardmængde, tilstand med tvungen blæser	0,65 kWh
Antal ovnrør	1
Varmekilde	Elektricitet
Rumfang	72 l
Ovntype	Indbygningsovn
Vægt	43,5 kg
* For EU i henhold til EU-forordning 65/2014 og 66/2014. For Belarus i henhold til STB 2478-2017, bilag G, STB 2477-2017, bilag A og B.	
Energiklasse gælder ikke for Rusland.	
EN 60350-1 – elektriske husholdningsapparater til madlavning – del 1: Komfurer, ovne, dampovne og grillapparater – metoder til måling af ydeevne.	

Produktbeskrivelse

Generell oversikt

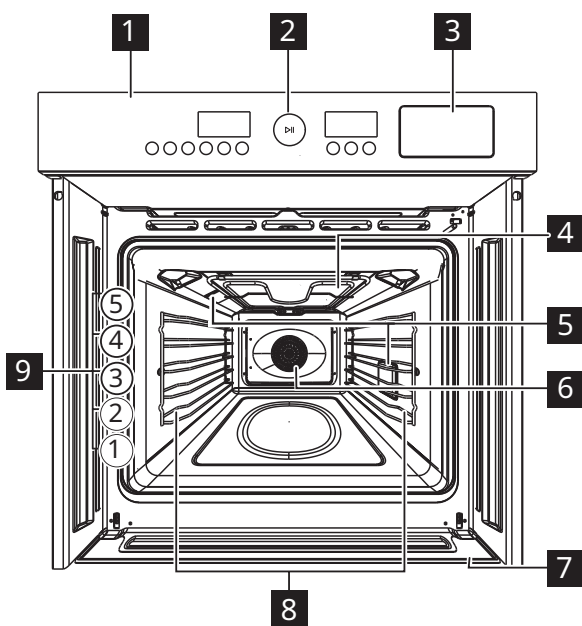

- 1 Kontrollpanel
- 2 Bryter for innstilling
- 3 Vannskuff
- 4 Grill
- 5 Lampe
- 6 Vifte
- 7 Vannoppsamler
- 8 Hyllestøtte, kan fjernes
- 9 Hylleposisjoner

Kontrollpanel

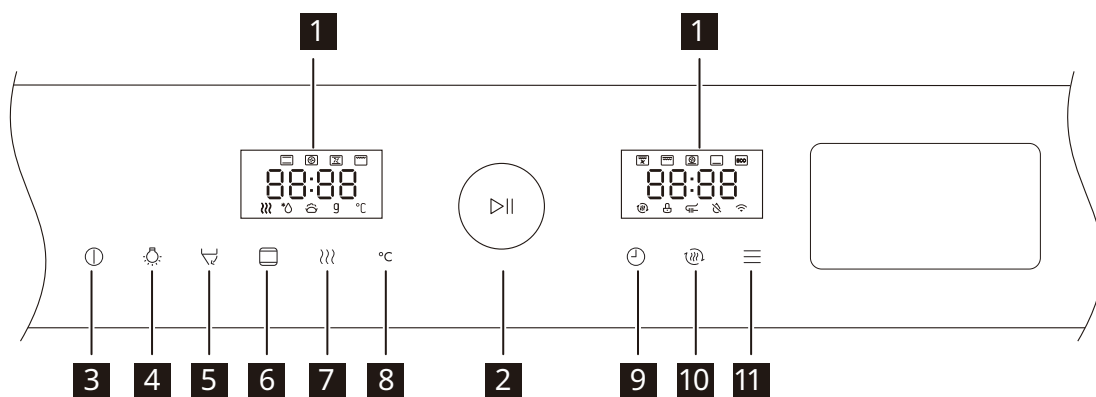

- 1 Skjerm
- 2 Knott
- 3 Avbryt
- 4 Lampe
- 5 Vannbeholder
- 6 Valg av modus
- 7 Damp
- 8 Temperatur
- 9 Tid
- 10 Rask forvarming
- 11 Auto meny

Skjerm

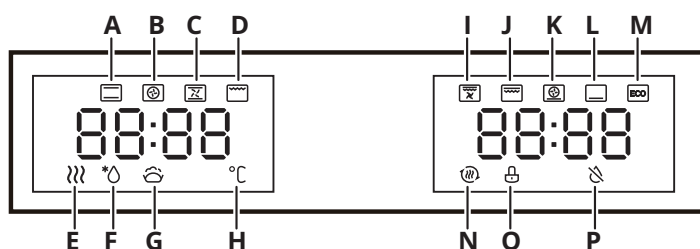

- | | |
|--------------------------|--------------------|
| A. Konvensjonell | J. Dobbel grill |
| B. Konveksjon | K. Pizza |
| C. Konvensjonell + vifte | L. Undervarme |
| D. Grill | M. ØKO |
| E. Damp | N. Rask forvarming |
| F. Tine | O. Barnesikring |
| G. Deigheving | P. Mangel på vann |
| H. Temperatur | |
| I. Dobbel grill + vifte | |

Oversikt over menyene

- | | | |
|--|------------------------------|--|
| | Konvensjonell | Bakte store kaker. |
| | Konveksjon | Passer spesielt godt til tilbereding av mat som skal ha jevn farge. |
| | Konvensjonell + vifte | Kombinasjonen av vifter og varmeelementer gir jevnere varmefordeling og sparer opptil 30–40 % strøm. |
| | Grill | Tilbered små mengder mat. |
| | Dobbel grill + vifte | Grille flat mat. |
| | Dobbel grill | Tilbered små mengder flat mat. |
| | Pizza | Steke pizza. |
| | Undervarme | Gi farge til undersiden av flate matretter. |
| | ØKO | For energisparing under matlagingen. |
| | Tine | Tine frossen mat. |
| | Deigheving | Heve deig eller fermentere yoghurt. |
| | Tørkefunksjon | Brukes for å tørke ovnen og forhindre bakterievekst. |
| | Rensing | Tilsett sitronsyre i vannbeholderen for å fjerne avleiringer i røret. |

Matlagingsmodus med dampfunksjon

- | | | | | | |
|--|----------------------|--|-------------------|--|------------------------------|
| | Konvensjonell | | Grill | | Konvensjonell + vifte |
| | Konveksjon | | Undervarme | | Damprengjøring |

Bruk av vannbeholder

Når du setter inn vannbeholderen igjen, må du sørge for at vannbeholderen skyves helt inn på plass.

Etter matlaging skal resten av vannet i vannbeholderen tømmes ut, og beholderen skal tørkes for å motvirke bakterievekst.

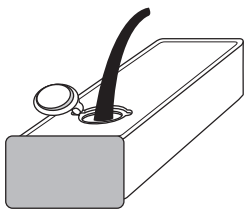

Når du bruker funksjonen for damp og den automatiske menyen, skal du fylle rent vann på vanntanken på forhånd.

metode 1

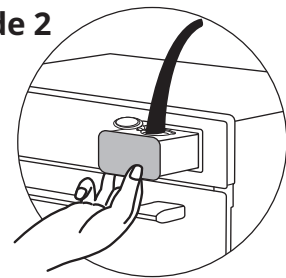

metode 2









1. Klikk på «»-knappen for å ta ut hele vannbeholderen, åpne gummiringen og fylle på vann.
2. Klikk på «»-knappen for å løsne vannbeholderen, åpne gummiringen og fylle på vann.

Feilsøking

Hvis du får problemer med apparatet, kan du lese feilsøkingskapittelet «Hva gjør jeg hvis» i den komplette versjonen

av brukerhåndboken, som du finner her: www.ikea.com.

Auto-meny

Skjerm	Meny	Modus eller temperatur	Tid	Forvarming
A01	Okseribbe	 250 °C	4 min	JA
A02	Biff med svart pepper	 250 °C	8 min	JA
A03	Chiffon-kake	 150 °C	50 min	JA
A04	Muffins	 160 °C	35 min	JA
A05	Fransk svinekotelett	 200 °C	50 min	JA
A06	Italiensk fruktpai (20 cm)	 190 °C	22 min	JA

A07	Profiterole	 190 °C	24 min	JA
A08	Stekt torsk	 250 °C	8 min	JA
A09	Stekte kyllingvinger	 L1 230 °C	25 min	JA
A10	Svineribbe	 L1 200 °C	25 min	NO
A11	Stekt saury	 L1 220 °C	14 min	JA
A12	Helstekt kylling	 L1 200 °C	45 min	JA
A13	Svinestek	 L1 180 °C	50 min	JA
A14	Franske lammekoteletter	 L1 220 °C	25 min	JA
A15	Fransk svineknokke	 L1 230 °C	80 min	NO
A16	Ostekake	 L1 160 °C	55 min	JA
A17	Sjokoladecake	 L1 180 °C	25 min	JA
A18	Nøttebrød	 L1 190 °C	30 min	JA

Tekniske data

Tekniske data

Mål (innside)	Bredde Høyde Dybde	503 mm 353 mm 386 mm
Område for stekebrett	1159 cm ²	
Øvre varmeelement	900 W	
Nedre varmeelement	1500 W	
Grill	1300 W	
Ring	1800 W	
Total klassifisering	3150 W	

Tekniske data

Spenning	220 – 240V~
Frekvens	50 – 60 Hz
Antall funksjoner	14

Besøk www.ikea.com for å laste ned den komplette versjonen

Tekniske data**Tekniske data**

Mål (innside)	Bredde Høyde Dybde	503 mm 353 mm 386 mm
Område for stekebrett	1159 cm ²	
Øvre varmeelement	900 W	
Nedre varmeelement	1500 W	
Grill	1300 W	
Ring	1800 W	
Total klassifisering	3150 W	

Tekniske data

Spenning	220 - 240V~
Frekvens	50 - 60 Hz
Antall funksjoner	14

Energieffektiv

Produktinformasjons og typeskilt*

Leverandørens navn	IKEA
Modellidentifisering	MÅGEBO 905-570-61
Energieffektivitetsindeks	76,9
Energiklasse	A+
Energiforbruk med standard belastning i konvensjonell modus	1,02 kWh
Energiforbruk med standard belastning i vifte modus	0,65 kWh
Antall hulrom	1
Varmekilde	Elektrisitet
Volum	72 l
Type ovn	Innebygget ovn
Masse	43,5 kg
* For EU i henhold til EU-forordning 65/2014 og 66/2014. For Hviterussland i henhold til STB 2478-2017, vedlegg G; STB 2477-2017, vedlegg A og B.	
Energiklassen er ikke gyldig for Russland.	
EN 60350-1 – Matlagingsapparater til husholdningsbruk – Del 1: Komfyrer, ovner, dampovner og griller – Metoder for å måle ytelse.	

Beskrivning av produkten

Allmän översikt

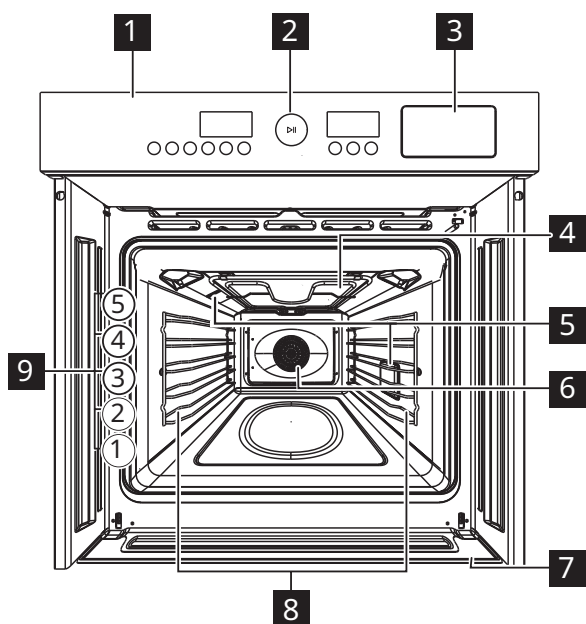

- 1** Kontrollpanel
- 2** Knopp för inställning
- 3** Vattenbehållare
- 4** Grill
- 5** Lampa
- 6** Fläkt
- 7** Vattensamlare
- 8** Hyllstöd, borttagbart
- 9** Hyllpositioner

Kontrollpanel

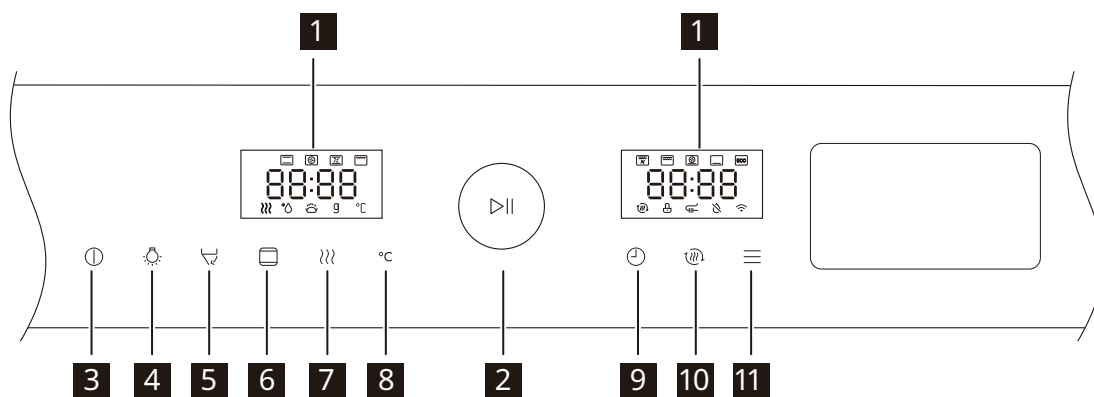

- 1** Display
- 2** Vred
- 3** Avbryt
- 4** Lampa
- 5** Vattenbehållare
- 6** Välja läge
- 7** Ånga
- 8** Temperatur
- 9** Tid
- 10** Snabb förvärmning
- 11** Automeny

Display

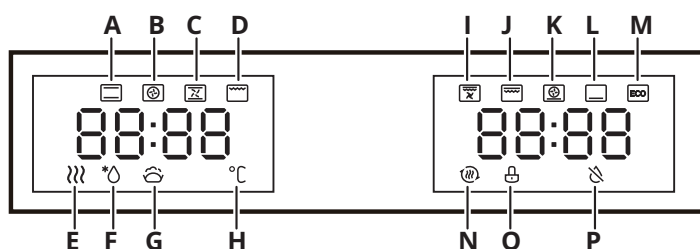

- | | |
|----------------------------|-------------------------|
| A. Konventionell | J. Dubbel grill |
| B. Konvektion | K. Pizza |
| C. Konvektion + fläkt | L. Undervärme |
| D. Grill | M. EKO |
| E. Ånga | N. Snabb
förvärmning |
| F. Avfrostning | O. Barnsäker |
| G. Jäsning av deg | P. Utan vatten |
| H. Temperatur | |
| I. Dubbel grill +
fläkt | |

En översikt över menyerna

- | | | |
|--|-----------------------------|--|
| | Konventionell | Stora bakverk. |
| | Konvektion | Särskilt lämplig för att tillaga mat som behöver ha en jämn färg. |
| | Konvektion + fläkt | Kombinationen av fläktar och värmeelement erbjuder en mer enhetlig värmeperetration vilket sparar upp till 30–40 % energi. |
| | Grill | Tillaga små mängder mat. |
| | Dubbel grill + fläkt | Grilla platt mat. |
| | Dubbel grill | Tillaga små mängder platt mat. |
| | Pizza | Baka pizza. |
| | Undervärme | Ger färg på undersidan av platt mat. |
| | EKO | För energisnål matlagning. |
| | Avfrostning | Tina upp fryst mat. |
| | Jäsning av deg | Jäst deg eller yoghurt. |
| | Torkfunktion | Den används för att torka ugnsutrymmet och förhindra att bakterier växer. |
| | Avkalka | Att tillsätta citronsyra i vattenbehållaren tar bort kalk i röret. |

Tillagningsläge med ångassistans

- | | | | | | |
|--|----------------------|--|-------------------|--|---------------------------|
| | Konventionell | | Grill | | Konvektion + fläkt |
| | Konvektion | | Undervärme | | Ångrengöring |

Används vattenbehållaren

Se till att vattenbehållaren trycks in hela vägen när den placeras på sin plats. Efter tillagning ska eventuellt kvarvarande vatten i vattenbehållaren tömmas och den ska torkas torr för att förhindra att bakterier växer. När ångassistansfunktionen och den automatiska menyn används ska du fylla på med renat vatten i förväg i vattenbehållaren.

sätt 1

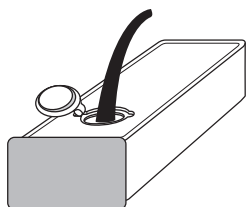

sätt 2

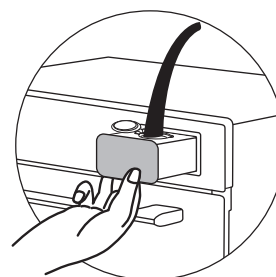







1. Tryck på knappen "☑" för att ta ut hela vattenbehållaren, öppna gummiringen och fyll på vatten.
2. Tryck på knappen "☑" för att skjuta ut vattenbehållaren, öppna gummiringen och fyll på vatten.

Felsökning

Om du får problem med apparaten kan du läsa kapitlet "Vad gör jag om ..." i den fullständiga versionen av

användarmanualen, som finns här: www.ikea.com.

Blad med automatiska menyer

Display	Meny	Läge eller temperatur	Tid	Förvärmning
A01	Helstekt revbensspjäll	 250 °C	4 min	JA
A02	Biff med svartpeppar	 250 °C	8 min	JA
A03	Chiffongtårta	 150 °C	50 min	JA
A04	Muffins med red velvet	 160 °C	35 min	JA
A05	Franskt grillad fläskkotlett	 200 °C	50 min	JA
A06	Italiensk fruktpaj (20 cm)	 190 °C	22 min	JA
A07	Petit-chou	 190 °C	24 min	JA

Gå till www.ikea.com för att ladda ner den fullständiga versionen

A08	Helstekt torsk	 250 °C	8 min	JA
A09	Grillade kycklingvingar	 L1 230 °C	25 min	JA
A10	Helstekt fläskkött av revben	 L1 200 °C	25 min	NEJ
A11	Ugnsstekt saury	 L1 220 °C	14 min	JA
A12	Helstekt kyckling	 L1 200 °C	45 min	JA
A13	Grillad skinka	 L1 180 °C	50 min	JA
A14	Fransk lammkotlett	 L1 220 °C	25 min	JA
A15	Franskt grillad fläsklägg	 L1 230 °C	80 min	NEJ
A16	Ostkaka	 L1 160 °C	55 min	JA
A17	Choklad- och tranbärsbröd	 L1 180 °C	25 min	JA
A18	Nötbröd	 L1 190 °C	30 min	JA

Tekniska data

Tekniska data

Mått (internt)	Bredd Höjd Djup	503 mm 353 mm 386 mm
Bakplåtens yta	1159 cm ²	
Övre värmeelement	900 W	
Nedre värmeelement	1500 W	
Grill	1300 W	
Ring	1800 W	
Total effekt	3150 W	

Tekniska data

Spänning	220 – 240 V~
Frekvens	50 – 60 Hz
Antal funktioner	14

Tekniska data**Tekniska data**

Mått (internt)	Bredd Höjd Djup	503 mm 353 mm 386 mm
Bakplåtens yta	1159 cm ²	
Övre värmeelement	900 W	
Nedre värmeelement	1500 W	
Grill	1300 W	
Ring	1800 W	
Total effekt	3150 W	

Tekniska data

Spänning	220 – 240 V~
Frekvens	50 – 60 Hz
Antal funktioner	14

Energieffektivitet

Produktinformation och produktinformationsblad*

Leverantörens namn	IKEA
Modellidentifiering	MÅGEBO 905-570-61
Energieffektivitetsindex	76,9
Energieffektivitetsklass	A+
Energiförbrukning med standardbelastning i konventionellt läge	1,02 kWh
Energiförbrukning med standardbelastning i fläktläge	0,65 kWh
Antal ugnsutrymmen	1
Värmekälla	Elektricitet
Volym	72 l
Typ av ugn	Inbyggd ugn
Vikt	43,5 kg
* För Europeiska unionen enligt EU-förordningarna 65/2014 och 66/2014. För Republiken Vitryssland enligt STB 2478-2017, bilaga G; STB 2477-2017, bilagorna A och B.	
Energieffektivitetsklassen är inte tillämplig för Ryssland.	
EN 60350-1 – Elektriska hushållsapparater – Del 1: Spisar, ugnar, ångugnar och grillar – Metoder för att mäta prestanda.	

Tuotteen kuvaus

Yleiskuvaus

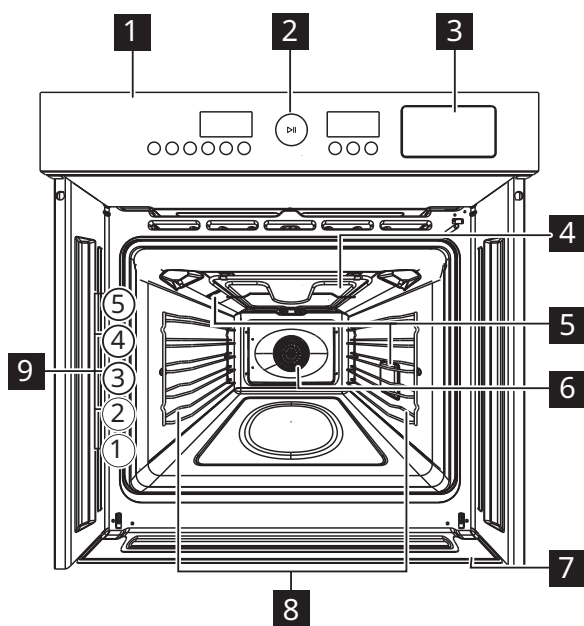

- 1 Käyttöpaneeli
- 2 Asetusnappi
- 3 Vesilokero
- 4 Grilli
- 5 Lamppu
- 6 Puhallin
- 7 Vedenkerääjä
- 8 Kannatintuki, irrotettava
- 9 Kannatintasot

Käyttöpaneeli

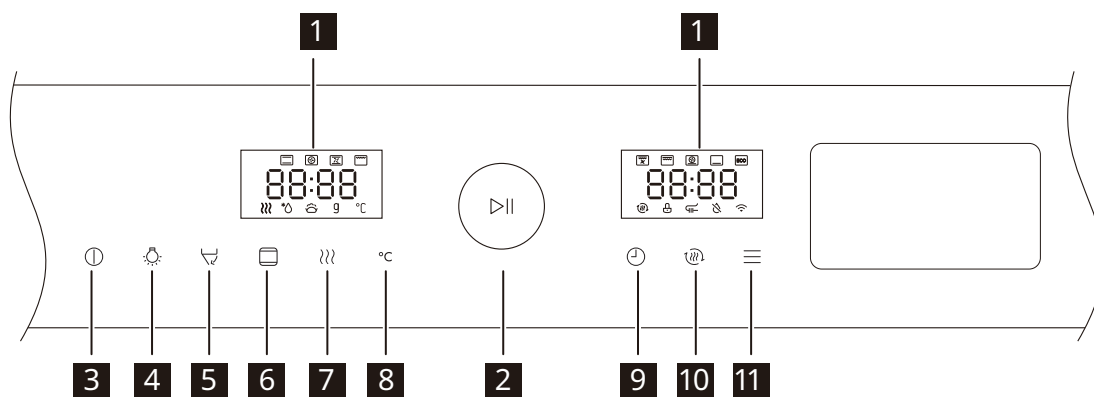

- 1 Näyttö
- 2 Nappi
- 3 Peruuta
- 4 Lamppu
- 5 Vesilaatikko
- 6 Tilan valinta
- 7 Höyry
- 8 Lämpötila
- 9 Aika
- 10 Nopea esikuumennus
- 11 Automaattivalikko

Näyttö

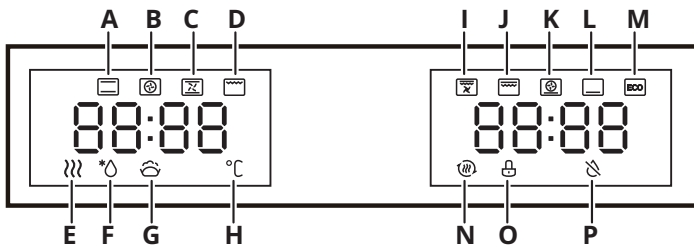

- | | |
|---------------------------|-----------------------------|
| A. Perinteinen | I. Kaksoisgrilli + puhallin |
| B. Kiertoilma | J. Kaksoisgrilli |
| C. Perinteinen + puhallin | K. Pizza |
| D. Grilli | L. Alalämpö |
| E. Höyry | M. ECO |
| F. Sulatus | N. Pikaesikuumennus |
| G. Taikinan nostatus | O. Lapsilukko |
| H. Lämpötila | P. Vesi loppu |

Yleiskatsaus valikoista

- | | | |
|--|---------------------------------|---|
| | Perinteinen | Isojen kakkujen paistaminen. |
| | Kiertoilma | Sopii erityisesti sellaisten ruokien valmistamiseen, joihin halutaan tasainen väri. |
| | Perinteinen + puhallin | Puhaltimien ja lämmityselementtien yhdistelmä tarjoaa tasaisemman lämmöntuoton ja säästää energiaa 30–40 %. |
| | Grilli | Pienten ruokamäärien valmistaminen. |
| | Kaksoisgrilli + puhallin | Matalien ruokien grillaaminen. |
| | Kaksoisgrilli | Pienten matalien ruokamäärien valmistaminen. |
| | Pizza | Pizzan paistamiseen. |
| | Alalämpö | Matalien ruokien pohjien ruskistamiseen. |
| | ECO | Energiaa säästävä valmistaminen. |
| | Sulatus | Pakasteiden sulattaminen. |
| | Taikinan nostatus | Taikinan nostatus tai jogurtin tekeminen. |
| | Kuivatustoiminto | Käytetään uunissa kuivaamiseen, estää bakteerien kasvua. |
| | Kalkinpoisto | Sitruunahapon lisääminen vesilaatikkoon putkessa olevan kalkin poistamiseksi. |

Höyryavusteinen valmistustila

- | | | | | | |
|--|--------------------|--|-----------------|--|-------------------------------|
| | Perinteinen | | Grilli | | Perinteinen + puhallin |
| | Kiertoilma | | Alalämpö | | Höyrypuhdistus |

Vesilaatikon käyttö

Kun laitat vesilaatikon takaisin säiliön paikkaan, varmista, että vesisäiliö on työnnetty kokonaan sisään.

Hävitä valmistuksen jälkeen vesilaatikossa jäljellä oleva vesi ja pyyhi laatikko kuivaksi, jotta bakteerit eivät pääse kasvamaan.

Kun käytät höyrytoimintoa ja automaattivalikkoa, lisää puhdistettua vettä vesisäiliöön etukäteen.

tapa 1

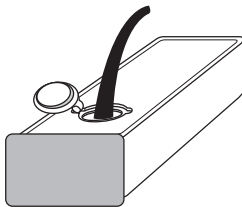

tapa 2

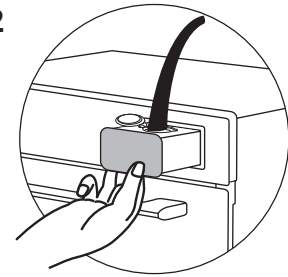

1. Napsauta "☒"-näppäintä poistaaksesi koko vesilaatikon, avaa kumitulppa ja lisää vettä.
2. Napsauta "☒"-näppäintä poistaaksesi vesilaatikon, avaa kumitulppa ja lisää vettä.





Vianmääritys

Jos laitteessa ilmenee ongelmia, tarkista luku "Mitä tehdä jos..." käyttöoppaan

täydellisestä versiosta, joka on saatavilla osoitteessa: www.ikea.com.

Automaattivalikkotaulukko

Näyttö	Valikko	Tila tai lämpötila	Aika	Esilämmitys
A01	Paahdettu naudankylki	250 °C	4 min	KYLLÄ
A02	Naudanlihapihvi mustapippurilla	250 °C	8 min	KYLLÄ
A03	Sifonkikakku	150 °C	50 min	KYLLÄ
A04	Red velvet -kuppikakut	160 °C	35 min	KYLLÄ
A05	Ranskalainen porsaankyljys	200 °C	50 min	KYLLÄ
A06	Italialainen hedelmäpiiras (8 tuumaa)	190 °C	22 min	KYLLÄ
A07	Tuulihatut	190 °C	24 min	KYLLÄ

A08	Paahdettu turska	 250 °C	8 min	KYLLÄ
A09	Paahdetut kanansiivet	 L1 230 °C	25 min	KYLLÄ
A10	Paahdettu porsaankylki	 L1 200 °C	25 min	EI
A11	Paahdettu saira	 L1 220 °C	14 min	KYLLÄ
A12	Paahdettu kana, kokonainen	 L1 200 °C	45 min	KYLLÄ
A13	Paahdettu porsas	 L1 180 °C	50 min	KYLLÄ
A14	Ranskalainen lampaankyljys	 L1 220 °C	25 min	KYLLÄ
A15	Ranskalainen paahdettu sianpotka	 L1 230 °C	80 min	EI
A16	Juustokakku	 L1 160 °C	55 min	KYLLÄ
A17	Suklaa-karpaloleipä	 L1 180 °C	25 min	KYLLÄ
A18	Pähkinäleipä	 L1 190 °C	30 min	KYLLÄ

Tekniset tiedot

Tekniset tiedot

Mitat (sisämitat)	Leveys Korkeus Syvyys	503 mm 353 mm 386 mm
Uunipellin alue	1159 cm ²	
Ylälämpövastus	900 W	
Alalämpövastus	1500 W	
Grilli	1300 W	
Rengas	1800 W	
Kokonaisteho	3150 W	

Tekniset tiedot

Jännite	220 – 240 V~
Taajuus	50 – 60 Hz
Toimintojen lukumäärä	14

Tekniset tiedot**Tekniset tiedot**

Mitat (sisämitat)	Leveys Korkeus Syvyys	503 mm 353 mm 386 mm
Uunipellin alue	1159 cm ²	
Ylälämpövastus	900 W	
Alalämpövastus	1500 W	
Grilli	1300 W	
Rengas	1800 W	
Kokonaisteho	3150 W	

Tekniset tiedot

Jännite	220 – 240 V~
Taajuus	50 – 60 Hz
Toimintojen lukumäärä	14

Energiatehokkuus

Tuotetiedot ja tuotteen tietolomake*

Tavarantoimittajan nimi	IKEA
Mallin yksilöinti	MÅGEBO 905-570-61
Energiatehokkuusindeksi	76,9
Energiatehokkuusluokka	A+
Energiankulutus vakiokuormalla, perinteisessä tilassa	1,02 kWh
Energiankulutus vakiokuormalla, kiertoilmatilassa	0,65 kWh
Uunikammioiden määrä	1
Lämpölähde	Sähkö
Tilavuus	72 l
Uunin tyyppi	Kalusteeseen asennettava uuni
Paino	43,5 kg
* Euroopan unionissa EU-asetusten 65/2014 ja 66/2014 mukaisesti. Valko-Venäjän tasavallassa standardin STB 2478-2017 liitteen G ja standardin STB 2477-2017 liitteiden A ja B mukaisesti.	
Energiatehokkuusluokka ei koske Venäjää.	
EN 60350-1 – Kotitalouksien sähkötoimiset ruoanlaittolaitteet, Osa 1: Liedet, uunit, höyryuunit ja grillit – Suorituskyvyn mittaustavat.	

Descrição do Produto

Vista geral

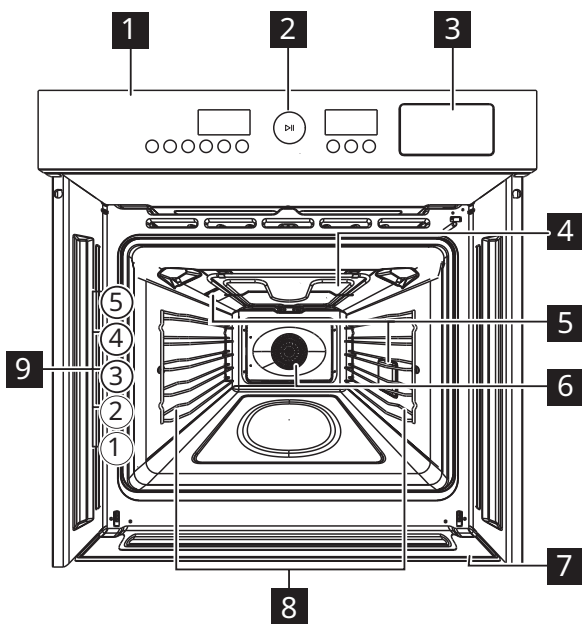

- 1 Painel de controlo
- 2 Botão para definição
- 3 Gaveta de água
- 4 Grelha
- 5 Lâmpada
- 6 Ventoinha
- 7 Coletor de água
- 8 Suporte de prateleira, amovível
- 9 Posições de prateleira

Painel de controlo

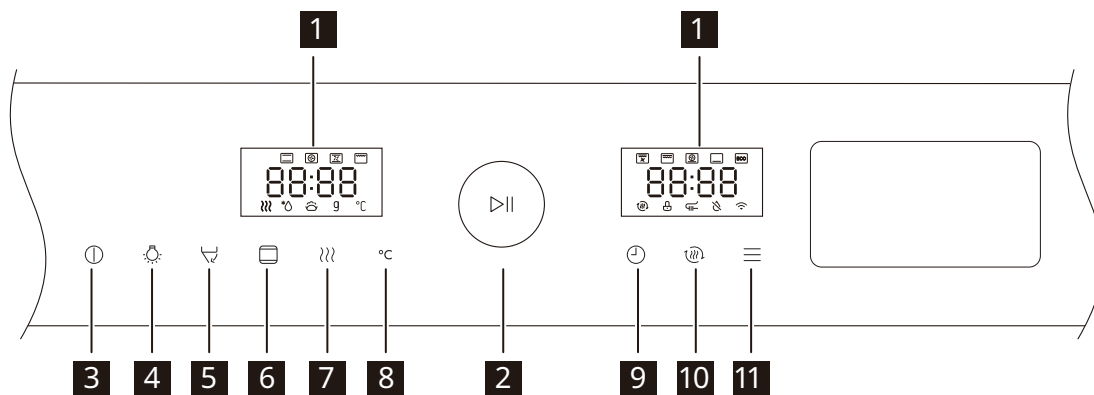

- 1 Ecrã
- 2 Botão
- 3 Cancelar
- 4 Lâmpada
- 5 Caixa de água
- 6 Seleção de modo
- 7 Vapor
- 8 Temperatura
- 9 Tempo
- 10 Pré-aquecimento rápido
- 11 Menu automático

Ecrã

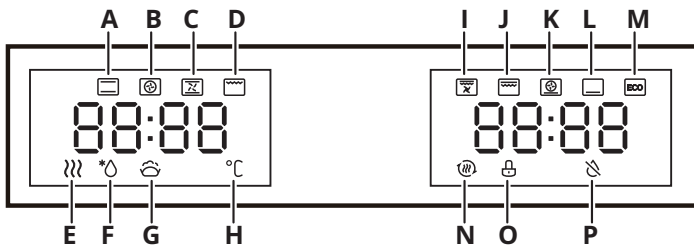

- | | |
|--------------------------------|------------------------------|
| A. Convencional | J. Grelhador duplo |
| B. Convecção | K. Pizza |
| C. Convencional + ventoinha | L. Calor do fundo |
| D. Grelha | M. ECO |
| E. Vapor | N. Pré-aquecimento rápido |
| F. Descongelação | O. À prova de crianças |
| G. Crescimento da massa | P. Falta de água + ventoinha |
| H. Temperatura | |
| I. Grelhador duplo + ventoinha | |

Vista geral dos menus

- | | | |
|--|------------------------------------|--|
| | Convencional | Bolos grandes. |
| | Convecção | Especialmente adequado para cozer alimentos que necessitem de ser uniformemente tostados. |
| | Convencional + ventoinha | A combinação de ventoinhas e elementos de aquecimento proporciona uma penetração mais uniforme do calor, economizando até 30-40% de energia. |
| | Grelha | Permite cozer quantidades pequenas de alimentos. |
| | Grelhador duplo + ventoinha | Churrasco de alimentos planos. |
| | Grelhador duplo | Permite cozer quantidades pequenas de alimentos planos. |
| | Pizza | Pizza cozinhada. |
| | Calor do fundo | Tosta o fundo dos alimentos planos. |
| | ECO | Para cozinhar com poupança de energia. |
| | Descongelação | Descongelar alimentos congelados. |
| | Crescimento da massa | Massa fermentada ou iogurte. |
| | Função de secagem | É utilizada para secar a câmara do forno e impedir o crescimento de bactérias. |
| | Descalcificação | Adicionando ácido cítrico à caixa de água, para remover a calcificação no tubo. |

Modo de cozedura com função auxiliar de vapor

- | | | | | | |
|--|---------------------|--|-----------------------|--|-------------------------------|
| | Convencional | | Grelha | | Convencional+ventoinha |
| | Convecção | | Calor do fundo | | Limpeza a vapor |

Caixa de água de utilização

Ao voltar a colocar a caixa de água no assento do depósito, certifique-se de que o depósito de água é empurrado completamente até ao limite.

Após cozinhar, deite fora qualquer água restante na caixa de água e seque-a, para impedir o crescimento de bactérias.

Ao utilizar a função de assistência a vapor e o menu automático, adicione previamente água purificada ao depósito de água.

via 1

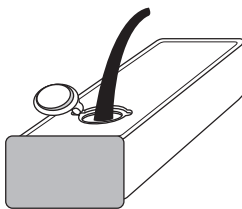

via 2

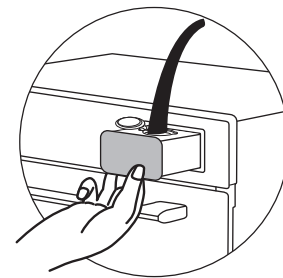

1. Clique na tecla "☑" para retirar a caixa de água completa, abra o anel de borracha e adicione água.
2. Clique na tecla "☑" para extrair a caixa de água completa, abra o anel de borracha e adicione água.

Resolução de problemas

Caso se depare com um problema com o seu eletrodoméstico, consulte o capítulo "O que fazer se..." na versão integral

do Manual de Utilizador disponível em: www.ikea.com.

Ficha de menu automático

Ecrã	Menu	Modo ou Temperatura	Tempo	Pré-aquecimento
A01	Costeletas de carne assada	250 °C	4 min.	SIM
A02	Bife de vaca com pimenta preta	250 °C	8 min.	SIM
A03	Bolo Chiffon	150 °C	50 min.	SIM
A04	Queque red velvet	160 °C	35 min.	SIM
A05	Costeleta de porco assada à francesa	200 °C	50 min.	SIM
A06	Tarte de fruta italiana (8 polegadas)	190 °C	22 min.	SIM

A07	Profiterole	 190 °C	24 min.	SIM
A08	Bacalhau assado	 250 °C	8 min.	SIM
A09	Asas de frango assadas	 L1 230 °C	25 min.	SIM
A10	Costeletas de porco assado	 L1 200 °C	25 min.	NÃO
A11	Lúcio de cavala assado	 L1 220 °C	14 min.	SIM
A12	Frango inteiro assado	 L1 200 °C	45 min.	SIM
A13	Carne de porco assada	 L1 180 °C	50 min.	SIM
A14	Costeleta de borrego à francesa	 L1 220 °C	25 min.	SIM
A15	Perna de porco assada	 L1 230 °C	80 min.	NÃO
A16	Cheesecake	 L1 160 °C	55 min.	SIM
A17	Pão de arando de chocolate	 L1 180 °C	25 min.	SIM
A18	Pão de nozes	 L1 190 °C	30 min.	SIM

Dados técnicos

Dados técnicos

Dimensões (interior)	Largura Altura Profundidade	503 mm 353 mm 386 mm
Área do tabuleiro para cozedura	1159 cm ²	
Elemento de aquecimento superior	900 W	
Elemento de aquecimento inferior	1500 W	
Grelha	1300 W	
Anel	1800 W	
Classificação total	3150 W	

Dados técnicos

Tensão	220 - 240 V~
Frequência	50 - 60 Hz
Número de funções	14

Dados técnicos**Dados técnicos**

Dimensões (interior)	Largura	503 mm
	Altura	353 mm
	Profundidade	386 mm
Área do tabuleiro para cozedura	1159 cm ²	
Elemento de aquecimento superior	900 W	
Elemento de aquecimento inferior	1500 W	
Grelha	1300 W	
Anel	1800 W	
Classificação total	3150 W	

Dados técnicos

Tensão	220 - 240 V~
Frequência	50 - 60 Hz
Número de funções	14

Eficiência energética

Informação e Ficha de Informação do Produto*

Nome do fabricante	IKEA
Identificação do modelo	MÅGEBO 905-570-61
Índice de eficiência energética	76,9
Classe de eficiência energética	A+
Consumo de energia com uma carga padrão, modo convencional	1,02 kWh
Consumo de energia com uma carga padrão, modo forçado por ventoinha	0,65 kWh
Número de cavidades	1
Fonte de calor	Eletricidade
Volume	72 l
Tipo de forno	Forno integrado
Massa	43,5 kg
* Para a União Europeia de acordo com os Regulamentos da UE 65/2014 e 66/2014. Para a República da Bielorrússia, em conformidade com o STB 2478-2017, Anexo G; STB 2477-2017, Anexos A e B.	
A classe de eficiência energética não é aplicável para a Rússia.	
EN 60350-1 - Aparelhos eletrodomésticos para cozinhar - Parte 1: Gamas, fornos, fornos a vapor e grelhadores - Métodos de medição do desempenho.	

Descripción del aparato

Descripción general

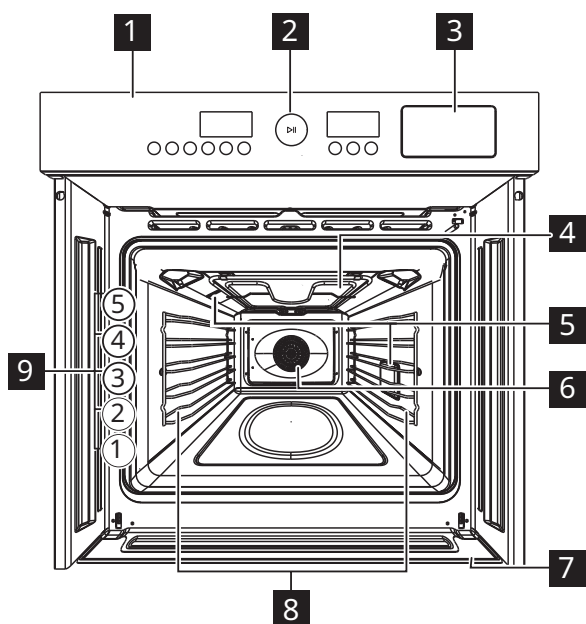

- 1** Panel de control
- 2** Mando de ajuste
- 3** Compartimento para el agua
- 4** Grill
- 5** Lámpara
- 6** Ventilador
- 7** Colector de agua
- 8** Soportes para las bandejas, extraíbles
- 9** Posiciones de las bandejas

Panel de control

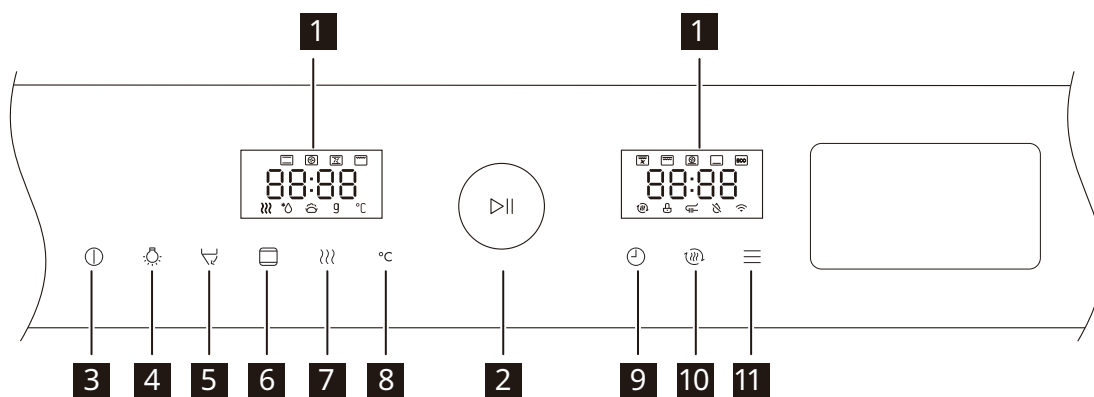

- 1** Pantalla
- 2** Mando giratorio
- 3** Cancelar
- 4** Lámpara
- 5** Compartimento para el agua
- 6** Selección de modo
- 7** Vapor
- 8** Temperatura
- 9** Tiempo
- 10** Precalentamiento rápido
- 11** Menú automático

Pantalla

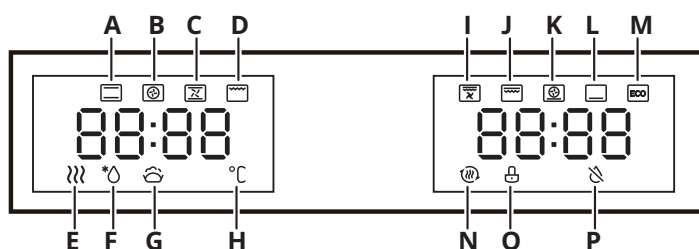

- | | |
|------------------------------|----------------------------|
| A. Convencional | J. Doble grill |
| B. Convección | K. Pizza |
| C. Convencional + ventilador | L. Calor inferior |
| D. Grill | M. ECO |
| E. Vapor | N. Precalentamiento rápido |
| F. Descongelación | O. Bloqueo para niños |
| G. Masa de fermentación | P. Falta de agua |
| H. Temperatura | |
| I. Doble grill + ventilador | |

Descripción general de los menús

- | | | |
|--|----------------------------------|---|
| | Convencional | Bizcochos grandes horneados. |
| | Convección | Es especialmente adecuado para hornear comidas que necesitan un tostado uniforme. |
| | Convencional + ventilador | La combinación de los ventiladores y las resistencias facilita una penetración más uniforme del calor, ahorrando hasta un 30 % - 40 % de energía. |
| | Parrilla | Para hornear pequeñas cantidades de alimentos. |
| | Doble grill + ventilador | Alimentos planos a la barbacoa. |
| | Doble grill | Para hornear pequeñas cantidades de alimentos planos. |
| | Pizza | Pizza al horno. |
| | Calor inferior | Para tostarla parte inferior de comidas planas. |
| | ECO | Para cocinar ahorrando energía. |
| | Descongelación | Para descongelar los alimentos congelados. |
| | Masa de fermentación | Para masa fermentada o yogur.
Se utiliza para secar la cámara del horno y prevenir el crecimiento de bacterias. |
| | Función de secado | |
| | Descalcificación | Se añade ácido cítrico al cajón del agua para eliminar la cal de la tubería. |

Modo de cocinado con función vapor

- | | | | | | |
|--|---------------------|--|-----------------------|--|----------------------------------|
| | Convencional | | Parrilla | | Convencional + ventilador |
| | Convección | | Calor inferior | | Limpieza con vapor |

Uso del compartimento para el agua

Cuando vuelva a colocar el compartimento para el agua en su alojamiento, asegúrese de que lo presiona hasta el final.

Elimine el agua que quede en el compartimento para el agua después del cocinado para prevenir el crecimiento de bacterias.

Cuando utilice la función auxiliar de vapor y el menú automático, llene previamente el depósito con agua purificada.

modo 1

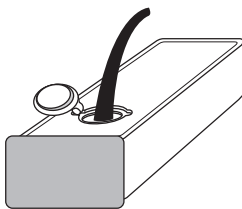

modo 2

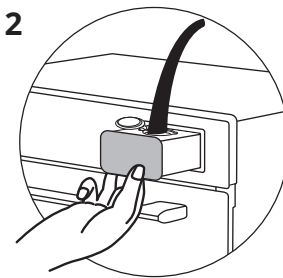

1. Pulse el botón «» para sacar completamente el compartimento para el agua, abra la tapa de goma y añada agua.
2. Pulse el botón «» para que salga el compartimento para el agua, abra la tapa de goma y añada agua.











Resolución de problemas

Si tiene algún problema con el aparato, consulte el capítulo «Qué hacer si...» en la

versión completa del manual del usuario, disponible en www.ikea.com.

Tabla de menús automáticos

Pantalla	Menú	Modo o temperatura	Tiempo	Precalentamiento
A01	Costillas de ternera asadas	250 °C	4 min	SÍ
A02	Bistec de ternera con pimienta negra	250 °C	8 min	SÍ
A03	Pastel chifón	150 °C	50 min	SÍ
A04	Cupcake red velvet	160 °C	35 min	SÍ
A05	Chuleta de cerdo asada a la francesa	200 °C	50 min	SÍ
A06	Pastel de frutas italiano (20 cm)	190 °C	22 min	SÍ
A07	Profiteroles	190 °C	24 min	SÍ

A08	Bacalao asado	 250 °C	8 min	SÍ
A09	Alitas de pollo asadas	 L1 230 °C	25 min	SÍ
A10	Costillas de cerdo asadas	 L1 200 °C	25 min	NA
A11	Paparda asada	 L1 220 °C	14 min	SÍ
A12	Pollo entero asado	 L1 200 °C	45 min	SÍ
A13	Cerdo asado	 L1 180 °C	50 min	SÍ
A14	Chuleta de cordero a la francesa	 L1 220 °C	25 min	SÍ
A15	Codillo de cerdo asado a la francesa	 L1 230 °C	80 min	NA
A16	Tarta de queso	 L1 160 °C	55 min	SÍ
A17	Pan de chocolate y arándanos	 L1 180 °C	25 min	SÍ
A18	Pan con nueces	 L1 190 °C	30 min	SÍ

Datos técnicos

Datos técnicos

Dimensiones (internas)	Ancho Alto Fondo	503 mm 353 mm 386 mm
Área de la bandeja para horno	1159 cm ²	
Resistencia superior	900 W	
Resistencia inferior	1500 W	
Grill	1300 W	
Anillo	1800 W	
Potencia total	3150 W	

Datos técnicos

Tensión	220 - 240 V
Frecuencia	50 - 60 Hz
Número de funciones	14

Datos técnicos

Datos técnicos

Dimensiones (internas)	Ancho	503 mm
	Alto	353 mm
	Fondo	386 mm
Área de la bandeja para horno	1159 cm ²	
Resistencia superior	900 W	
Resistencia inferior	1500 W	
Grill	1300 W	
Anillo	1800 W	
Potencia total	3150 W	

Datos técnicos

Tensión	220 - 240 V
Frecuencia	50 - 60 Hz
Número de funciones	14

Eficiencia energética

Información del producto y ficha de información del producto*

Nombre del proveedor	IKEA
Identificación del modelo	MÅGEBO 905-570-61
Índice de eficiencia energética	76,9
Clase de eficiencia energética	A+
Consumo de energía con carga estándar en modo convencional	1,02 kWh
Consumo de energía con carga estándar en modo de ventilación forzada	0,65 kWh
Número de cavidades	1
Fuente de calor	Electricidad
Volumen	72 l
Tipo de horno	Horno empotrado
Peso	43,5 kg
* Para la Unión Europea, de conformidad con las normas UE 65/2014 y 66/2014. Para la República de Bielorrusia, conforme al STB 2478-2017, Apéndice G y STB 2477-2017, Anexos A y B.	
La clase de eficiencia energética no es aplicable en Rusia.	
EN 60350-1: Aparatos electrodomésticos de cocción. Parte 1: Cocinas, hornos, hornos de vapor y gratinadores. Métodos de medida de la aptitud a la función.	

Περιγραφή προϊόντος

Γενική περιγραφή

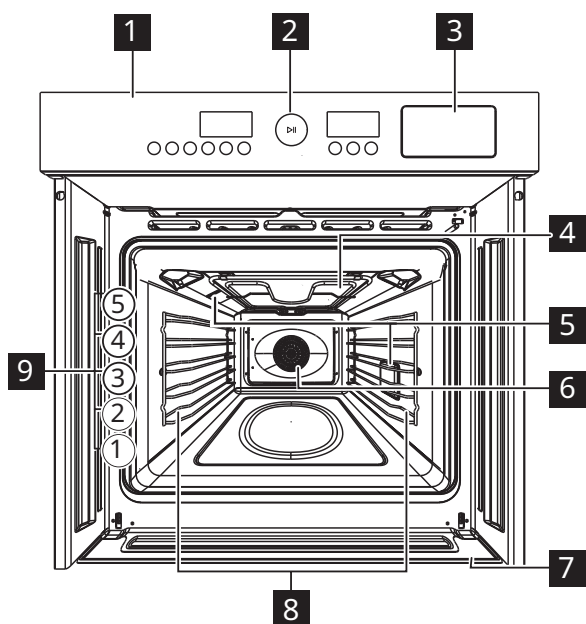

- 1 Πίνακας ελέγχου
- 2 Κουμπί ρύθμισης
- 3 Συρτάρι νερού
- 4 Γκριλ
- 5 Λάμπα
- 6 Ανεμιστήρας
- 7 Συλλέκτης νερού
- 8 Στήριξη σχάρας, αφαιρούμενη
- 9 Θέσεις για σχάρες

Πίνακας ελέγχου

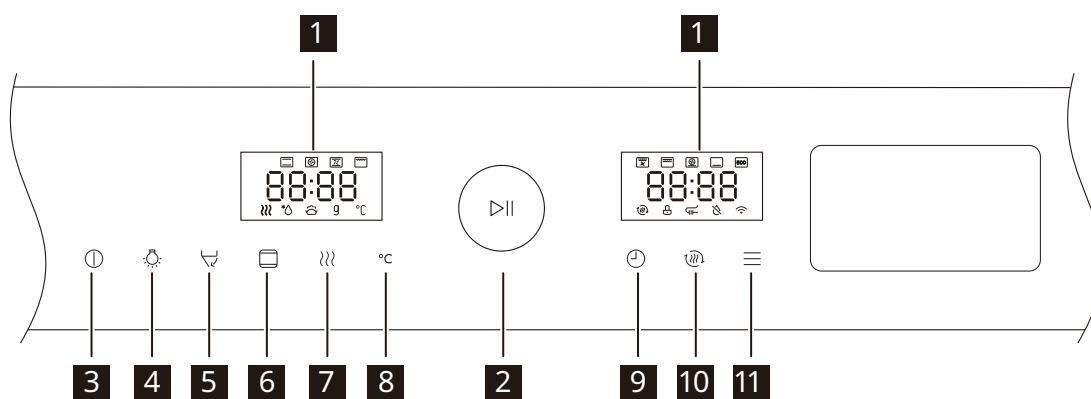

- 1 Οθόνη
- 2 Περιστροφικός διακόπτης
- 3 Ακύρωση
- 4 Λάμπα
- 5 Δοχείο νερού
- 6 Επιλογή λειτουργίας
- 7 Ατμός
- 8 Θερμοκρασία
- 9 Χρόνος
- 10 Ταχεία προθέρμανση
- 11 Αυτόματο μενού

Για να πραγματοποιήσετε λήψη της πλήρους έκδοσης, επισκεφθείτε τη διεύθυνση www.ikea.com

Οθόνη

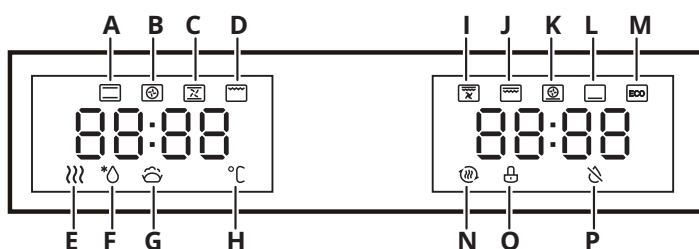

- A. Συμβατική λειτουργία
- B. Μεταφορά θερμότητας
- C. Συμβατική λειτουργία + ανεμιστήρας
- D. Γκριλ
- E. Ατμός
- F. Απόψυξη
- G. Διόγκωση ζύμης
- H. Θερμοκρασία
- I. Διπλό γκριλ + ανεμιστήρας
- J. Διπλό γκριλ
- K. Πίτσα
- L. Θέρμανση κάτω
- M. ECO
- N. Γρήγορη προθέρμανση
- O. Παιδικό κλείδωμα
- P. Έλλειψη νερού

Προεπισκόπηση των μενού

	Συμβατική λειτουργία	Μεγάλα κέικ.
	Μεταφορά θερμότητας	Ιδιαίτερα κατάλληλη για το ψήσιμο τροφίμων που πρέπει να έχουν ομοιόμορφο χρώμα.
	Συμβατική λειτουργία + ανεμιστήρας	Ο συνδυασμός ανεμιστήρων και θερμαντικών στοιχείων παρέχει πιο ομοιόμορφη διείσδυση της θερμότητας, εξοικονομώντας έως και 30-40% της ενέργειας.
	Γκριλ	Ψήστε μικρές ποσότητες φαγητού.
	Διπλό γκριλ + ανεμιστήρας	Επίπεδα τρόφιμα.
	Διπλό γκριλ	Μικρές ποσότητες επίπεδων τροφίμων.
	Πίτσα	Ψημένη πίτσα.
	Θέρμανση κάτω	Ρόδισμα κάτω μέρους επίπεδων τροφίμων.
	ECO	Για μαγείρεμα με εξοικονόμηση ενέργειας.
	Απόψυξη	Απόψυξη κατεψυγμένων τροφίμων.
	Διόγκωση ζύμης	Ζύμωση ζύμης ή γιαουρτιού.
	Λειτουργία στεγνώματος	Χρησιμοποιείται για το στέγνωμα του θαλάμου φούρνου και την αποτροπή της ανάπτυξης βακτηρίων.
	Αφαλάτωση	Με την προσθήκη κιτρικού οξέος στο δοχείο νερού, για την απομάκρυνση αλάτων από τον σωλήνα.

Λειτουργία μαγειρέματος με λειτουργία υποβοήθησης ατμού

- | | | | | | |
|--|----------------------|--|---------------|--|------------------------------------|
| | Συμβατική λειτουργία | | Γκριλ | | Συμβατική λειτουργία + ανεμιστήρας |
| | Μεταφορά θερμότητας | | Θέρμανση κάτω | | Καθαρισμός με ατμό |

Για να πραγματοποιήσετε λήψη της πλήρους έκδοσης, επισκεφθείτε τη διεύθυνση www.ikea.com

Χρήση δοχείου νερού

Κατά την επανατοποθέτηση του δοχείου νερού στη θέση του, βεβαιωθείτε ότι το δοχείο νερού έχει τοποθετηθεί σωστά.

Μετά το μαγείρεμα, απορρίψτε το νερό που έχει απομείνει στο δοχείο νερού και σκουπίστε το, προκειμένου να μην αναπτυχθούν βακτήρια.

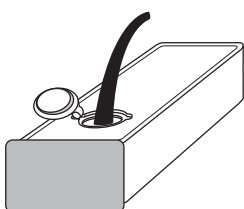

Όταν χρησιμοποιείτε τη λειτουργία υποβοήθησης ατμού και το αυτόματο μενού, προσθέστε εκ των προτέρων κεκαθαρμένο νερό στο δοχείο νερού.

τρόπος 1

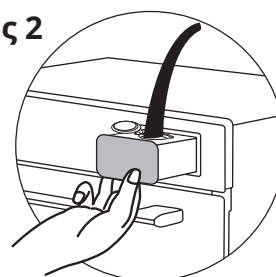

τρόπος 2



1. Πατήστε το πλήκτρο «» για να αφαιρέσετε ολόκληρο το δοχείο νερού, ανοίξτε τον ελαστικό δακτύλιο και προσθέστε νερό.
2. Πατήστε το πλήκτρο «» για να βγάλετε το δοχείο νερού, ανοίξτε τον ελαστικό δακτύλιο και προσθέστε νερό.

Αντιμετώπιση προβλημάτων

Εάν αντιμετωπίσετε κάποιο πρόβλημα με τη συσκευή σας, ανατρέξτε στο κεφάλαιο «Τι να κάνετε αν...» στην πλήρη έκδοση του

εγχειριδίου χρήσης που διατίθεται στη διεύθυνση: www.ikea.com.

Φύλλο αυτόματου μενού

Οθόνη	Μενού	Λειτουργία ή Θερμοκρασία	Χρόνος	Προθέρμανση
A01	Ψητά μοσχαρίσια παιδάκια	 250 °C	4 λεπτά	ΝΑΙ
A02	Μοσχαρίσια μπριζόλα με μαύρο πιπέρι	 250 °C	8 λεπτά	ΝΑΙ
A03	Κέικ σιφόν	 150 °C	50 λεπτά	ΝΑΙ
A04	Κεκάκι red velvet	 160 °C	35 λεπτά	ΝΑΙ
A05	Χοιρινές πανσέτες	 200 °C	50 λεπτά	ΝΑΙ
A06	Ιταλική πίτα φρούτων (8 ίντσες)	 190 °C	22 λεπτά	ΝΑΙ

Για να πραγματοποιήσετε λήψη της πλήρους έκδοσης, επισκεφθείτε τη διεύθυνση www.ikea.com

A07	Βολοβάν	 190 °C	24 λεπτά	ΝΑΙ
A08	Ψητός μπακαλιάρος	 250 °C	8 λεπτά	ΝΑΙ
A09	Ψητές φτερούγες κοτόπουλου	 L1 230 °C	25 λεπτά	ΝΑΙ
A10	Ψητά χοιρινά παϊδάκια	 L1 200 °C	25 λεπτά	ΟΧΙ
A11	Ψητό σαουρί	 L1 220 °C	14 λεπτά	ΝΑΙ
A12	Ψητό κοτόπουλο ολόκληρο	 L1 200 °C	45 λεπτά	ΝΑΙ
A13	Ψητό χοιρινό	 L1 180 °C	50 λεπτά	ΝΑΙ
A14	Αρνίσια παϊδάκια	 L1 220 °C	25 λεπτά	ΝΑΙ
A15	Χοιρινό κότσι	 L1 230 °C	80 λεπτά	ΟΧΙ
A16	Τσιζκέικ	 L1 160 °C	55 λεπτά	ΝΑΙ
A17	Κέικ με μούρα και σοκολάτα	 L1 180 °C	25 λεπτά	ΝΑΙ
A18	Ψωμί με ξηρούς καρπούς	 L1 190 °C	30 λεπτά	ΝΑΙ

Τεχνικά στοιχεία

Τεχνικά στοιχεία

Διαστάσεις (εσωτερικές)	Πλάτος Ύψος Βάθος	503 mm 353 mm 386 mm
Εμβαδόν ταψιού ψησίματος	1'159 cm ²	
Επάνω θερμαντικό στοιχείο	900 W	
Κάτω θερμαντικό στοιχείο	1'500 W	
Γκριλ	1'300 W	
Δακτύλιος	1'800 W	
Συνολική ονομαστική τιμή	3'150 W	

Τεχνικά στοιχεία

Τάση	220 - 240V~
Συχνότητα	50 - 60 Hz
Αριθμός λειτουργιών	14

Για να πραγματοποιήσετε λήψη της πλήρους έκδοσης, επισκεφθείτε τη διεύθυνση www.ikea.com

Τεχνικά στοιχεία**Τεχνικά στοιχεία**

Διαστάσεις (εσωτερικές)	Πλάτος Ύψος Βάθος	503 mm 353 mm 386 mm
Εμβαδόν ταψιού ψησίματος	1'159 cm ²	
Επάνω θερμαντικό στοιχείο	900 W	
Κάτω θερμαντικό στοιχείο	1'500 W	
Γκριλ	1'300 W	
Δακτύλιος	1'800 W	
Συνολική ονομαστική τιμή	3'150 W	

Τεχνικά στοιχεία

Τάση	220 - 240V~
Συχνότητα	50 - 60 Hz
Αριθμός λειτουργιών	14

Ενεργειακή απόδοση

Πληροφορίες προϊόντος και Φύλλο πληροφοριών προϊόντος*

Όνομα προμηθευτή	IKEA
Αναγνώριση μοντέλου	MÅGEBO 905-570-61
Δείκτης ενεργειακής κλάσης	76,9
Ενεργειακή κλάση	A+
Κατανάλωση ενέργειας με τυπικό φορτίο, συμβατική λειτουργία	1,02kWh
Κατανάλωση ενέργειας με τυπικό φορτίο, λειτουργία ανεμιστήρα	0,65kWh
Αριθμός θαλάμων	1
Πηγή θερμότητας	Ηλεκτρική ενέργεια
Όγκος	72 l
Τύπος φούρνου	Εντοιχιζόμενος φούρνος
Μάζα	43,5 kg
* Για την Ευρωπαϊκή Ένωση σύμφωνα με τους κανονισμούς EE 65/2014 και 66/2014. Για τη Δημοκρατία της Λευκορωσίας σύμφωνα με το STB 2478-2017, παράρτημα G, STB 2477-2017, παραρτήματα A και B.	
Η κατηγορία ενεργειακής απόδοσης δεν ισχύει για τη Ρωσία.	
EN 60350-1 - Οικιακές ηλεκτρικές συσκευές μαγειρέματος - Μέρος 1: Εστίες, φούρνοι, φούρνοι ατμού και ψησταριές - Μέθοδοι μέτρησης απόδοσης.	

Productbeschrijving

Algemeen overzicht

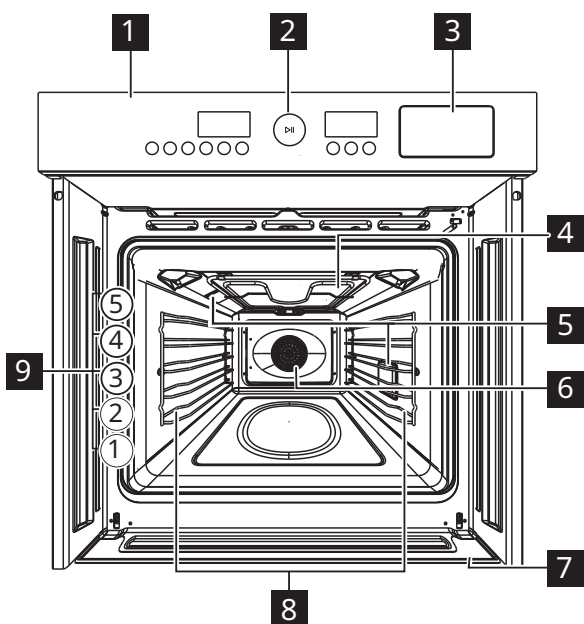

- 1 Bedieningspaneel
- 2 Instelknop
- 3 Waterlade
- 4 Grill
- 5 Lamp
- 6 Ventilator
- 7 Watercollector
- 8 Reksteun, uitneembaar
- 9 Rekposities

Bedieningspaneel

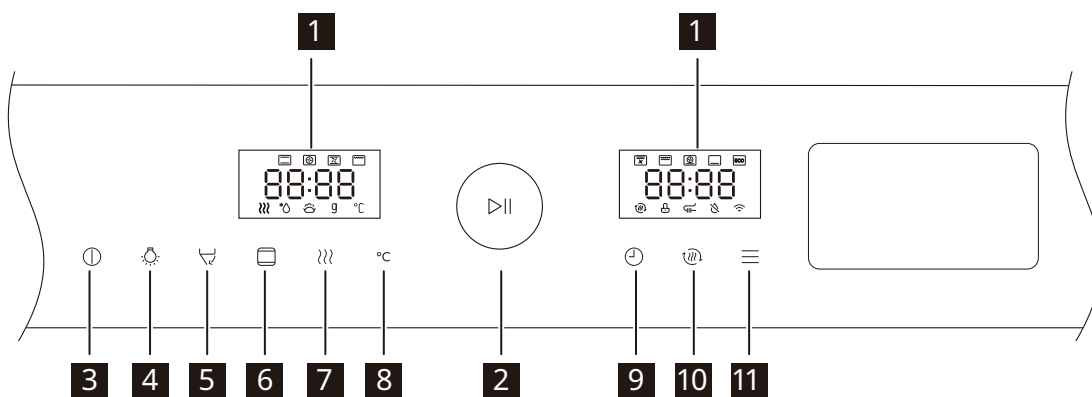

- 1 Display
- 2 Knop
- 3 Annuleren
- 4 Lamp
- 5 Waterreservoir
- 6 Modusselectie
- 7 Stoom
- 8 Temperatuur
- 9 Tijd
- 10 Snel voorverwarmen
- 11 Auto Menu

Display

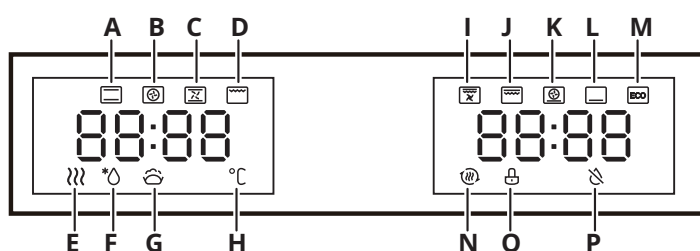

- | | |
|-------------------------------|-------------------------------|
| A. Conventioneel | I. Dubbele grill + ventilator |
| B. Convectie | J. Dubbele grill |
| C. Conventioneel + ventilator | K. Pizza |
| D. Grill | L. Onderverwarming |
| E. Stoom | M. ECO |
| F. Ontdooien | N. Snel voorverwarmen |
| G. Deeg rijzen | O. Kinderslot |
| H. Temperatuur | P. Tekort aan water |

Overzicht van de menu's

- | | | |
|--|-----------------------------------|---|
| | Conventioneel | Grote gebakken cakes. |
| | Convectie | Met name geschikt voor het bakken van voedsel dat gelijkmatig gebruikt moet worden. |
| | Conventioneel + ventilator | De combinatie van ventilatoren en verwarmingselementen zorgt voor een meer uniforme warmtepenetratie, waardoor tot 30-40% energie wordt bespaard. |
| | Grill | Voor het bakken van kleine hoeveelheden voedsel. |
| | Dubbele grill + ventilator | Vlak voedsel barbecueën. |
| | Dubbele grill | Voor het bakken van kleine hoeveelheden vlak voedsel. |
| | Pizza | Gebakken pizza. |
| | Onderverwarming | De onderkant van vlak voedsel bruinen. |
| | ECO | Voor energiebesparend koken. |
| | Ontdooien | Bevroren voedsel ontdooien. |
| | Deeg rijzen | Gefermenteerd deeg of yoghurt. |
| | Droogfunctie | Gebuikt om de ovenruimte te drogen en groei van bacteriën te voorkomen. |
| | Ontkalken | Door citroenzuur toe te voegen aan het waterreservoir, wordt kalkaanslag in de leiding verwijderd. |

Kookmodus met stoomassistentfunctie

- | | | | | | |
|--|----------------------|--|------------------------|--|-----------------------------------|
| | Conventioneel | | Grill | | Conventioneel + ventilator |
| | Convectie | | Onderverwarming | | Stoomreiniging |

Het waterreservoir gebruiken

Wanneer u het waterreservoir terug in de houder plaatst, dient u ervoor te zorgen dat het waterreservoir er volledig in is gedrukt.

Gooi na het koken het resterende water in het waterreservoir weg en veeg droog om de groei van bacteriën te voorkomen.

Wanneer u de stoomassistent en het automatische menu gebruikt, dient u het waterreservoir met vooraf gezuiverd water te vullen.

manier 1

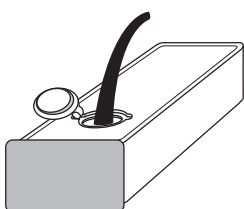

manier 2

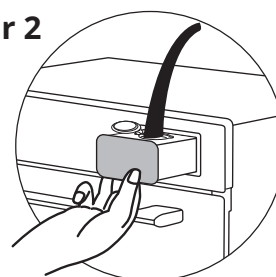

1. Druk op de toets "↵" om het gehele waterreservoir eruit te halen, open de rubberen ring en vul met water.
2. Druk op de toets "↵" om het waterreservoir eruit te laten springen, open de rubberen ring en vul met water.

Probleemoplossing

Als u een probleem ondervindt met uw apparaat, raadpleeg dan het hoofdstuk "Wat te doen..." in de volledige versie van

de Gebruikershandleiding die beschikbaar is op: www.ikea.com.

Overzicht van het automatische menu

Display	Menu	Modus of temperatuur	Tijd	Voorverwarmen
A01	Gebraden runderribbetjes	250°C	4 min.	JA
A02	Biefstuk met zwarte peper	250°C	8 min.	JA
A03	Chiffontaart	150°C	50 min.	JA
A04	Rode fluwelen cupcake	160°C	35 min.	JA
A05	Franse gebraden karbonade	200°C	50 min.	JA
A06	Italiaanse fruittaart (8 inch)	190°C	22 min.	JA

A07	Roomsoesjes	 190°C	24 min.	JA
A08	Gebraden kabeljauw	 250°C	8 min.	JA
A09	Gebraden kippenvleugels	 L1 230°C	25 min.	JA
A10	Gebraden varkensribbetjes	 L1 200°C	25 min.	NEE
A11	Gebraden makreel	 L1 220°C	14 min.	JA
A12	Gebraden hele kip	 L1 200°C	45 min.	JA
A13	Gebraden varkensvlees	 L1 180°C	50 min.	JA
A14	Franse lamskotelet	 L1 220°C	25 min.	JA
A15	Franse gebraden karbonade	 L1 230°C	80 min.	NEE
A16	Cheesecake	 L1 160°C	55 min.	JA
A17	Chocolade cranberry brood	 L1 180°C	25 min.	JA
A18	Notenbrood	 L1 190°C	30 min.	JA

Technische gegevens

Technische gegevens

Afmetingen (intern)	Breedte Hoogte Diepte	503 mm 353 mm 386 mm
Zone van bakplaat	1159 cm ²	
Bovenste verwarmingselement	900 W	
Onderste verwarmingselement	1500 W	
Grill	1300 W	
Ring	1800 W	
Totaal nominaal vermogen	3150 W	

Technische gegevens

Spanning	220 - 240 V~
Frequentie	50 - 60 Hz
Aantal functies	14

Technische gegevens

Technische gegevens

Afmetingen (intern)	Breedte Hoogte Diepte	503 mm 353 mm 386 mm
Zone van bakplaat	1159 cm ²	
Bovenste verwarmingselement	900 W	
Onderste verwarmingselement	1500 W	
Grill	1300 W	
Ring	1800 W	
Totaal nominaal vermogen	3150 W	

Technische gegevens

Spanning	220 - 240 V~
Frequentie	50 - 60 Hz
Aantal functies	14

Energie-efficiëntie

Productinformatien en productinformatieoverzicht*

Naam leverancier	IKEA
Modelidentificatie	MÅGEBO 905-570-61
Energie-efficiëntie-index	76,9
Energie-efficiëntieklasse	A+
Energieverbruik met standaard last, conventionele modus	1,02kWh
Energieverbruik met standaard last, ventilator-geforceerde modus	0,65kWh
Aantal ovenruimtes	1
Warmtebron	Elektriciteit
Volume	72 l
Type oven	Inbouwoven
Gewicht	43,5 kg
* Voor de Europese Unie volgens EU-richtlijnen 65/2014 en 66/2014. Voor de Republiek Wit-Rusland volgens STB 2478-2017, Bijlage G; STB 2477-2017, Bijlagen A en B.	
Energie-efficiëntieklasse is niet van toepassing voor Rusland.	
EN 60350-1 - Huishoudelijke elektrische kooktoestellen - Deel 1: Fornuizen, ovens, stoomovens en grillen - Methoden voor prestatiemeting.	

Opis urządzenia

Widok ogólny

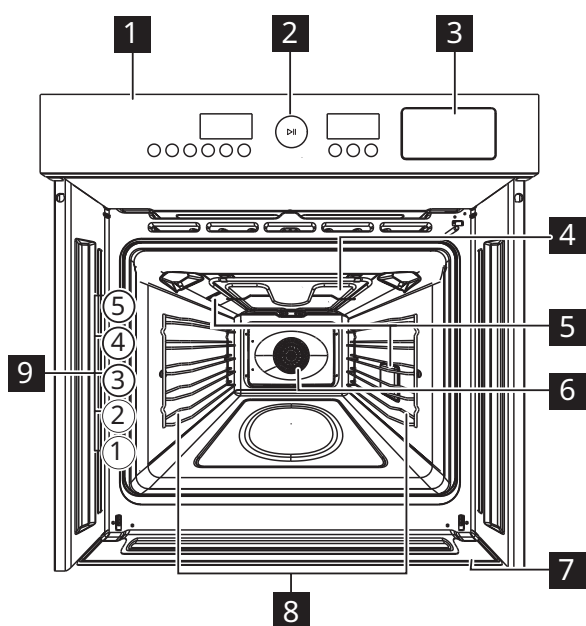

- 1 Panel sterowania
- 2 Pokrętko ustawień
- 3 Pojemnik na wodę
- 4 Grill
- 5 Lampa
- 6 Wentylator
- 7 Zbiornik wody
- 8 Drabinka na półki, wyjmowana
- 9 Poziomy umieszczenia tac

Panel sterowania

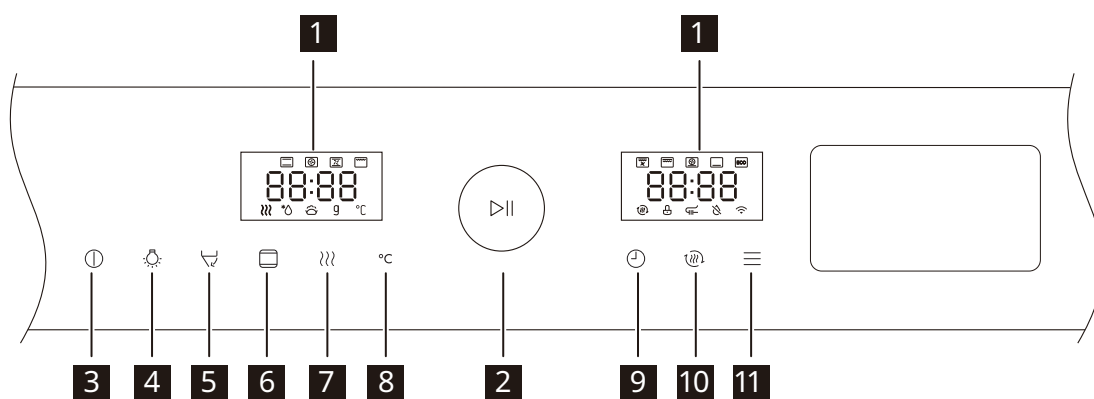

- 1 Wyświetlacz
- 2 Pokrętko
- 3 Anuluj
- 4 Lampa
- 5 Pojemnik na wodę
- 6 Wybór trybu
- 7 Para
- 8 Temperatura
- 9 Czas
- 10 Szybkie rozgrzewanie
- 11 Menu trybu automatycznego

Wyświetlacz

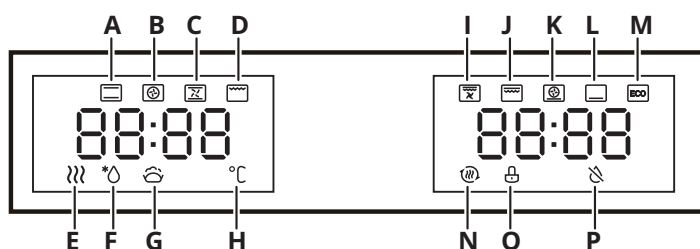

- | | |
|--------------------------------|---------------------------------|
| A. Zwykły | J. Podwójny grill |
| B. Konwekcyjny | K. Pizza |
| C. Zwykły + wentylator | L. Grzałka dolna |
| D. Grill | M. ECO |
| E. Para | N. Szybkie rozgrzewanie |
| F. Rozmrażanie | O. Zabezpieczenie przed dziećmi |
| G. Wyrastanie ciasta | P. Brak wody |
| H. Temperatura | |
| I. Podwójny grill + wentylator | |

Przegląd menu

- | | | |
|--|------------------------------------|---|
| | Zwykły | Pieczenie dużych ciast. |
| | Konwekcyjny | Szczególnie zalecany do pieczenia potraw, które powinny być równomiernie upieczone. |
| | Zwykły + wentylator | Połączenie wentylatorów i grzałek zapewnia bardziej równomierne rozprzaskanie ciepła, co skutkuje oszczędnością energii: do 30 – 40%. |
| | Kratka wentylacyjna | Do niewielkich porcji żywności. |
| | Podwójny grill + wentylator | Opiekanie płaskich porcji żywności. |
| | Podwójny grill | Opiekanie niewielkich, płaskich porcji żywności. |
| | Pizza | Pieczenie pizzy. |
| | Grzałka dolna | Opiekanie spodów płaskich porcji żywności. |
| | ECO | Pieczenie energooszczędne. |
| | Rozmrażanie | Rozmrażanie zamrożonej żywności. |
| | Wyrastanie ciasta | Fermentacja ciasta lub jogurtu. |
| | Suszenie | Służy do wysuszenia komory piekarnika i zapobiega rozwojowi bakterii. |
| | Odkamienianie | Do pojemnika na wodę wsypać kwasek cytrynowy, aby usunąć kamień z przewodów. |

Tryb pracy z funkcją wspomaganą parą

- | | | | | | |
|--|--------------------|--|----------------------------|--|----------------------------|
| | Zwykły | | Kratka wentylacyjna | | Zwykły + wentylator |
| | Konwekcyjny | | Grzałka dolna | | Czyszczenie parowe |

Korzystanie z pojemnika na wodę

Umieszczając pojemnik na wodę w gnieździe pojemnika, upewnić się, że pojemnik został całkowicie wsunięty.

Po zakończeniu obróbki termicznej usunąć wodę pozostałą w pojemniku i wytrzeć go do sucha, aby zapobiec gromadzeniu się bakterii.

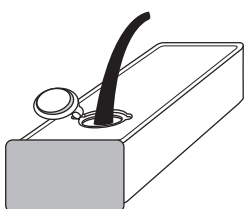

Gdy używana jest funkcja pary i automatyczne menu, należy wcześniej wlać do pojemnika filtrowaną wodę.

sposób 1

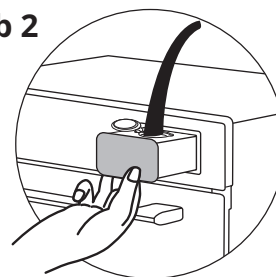

sposób 2









1. Nacisnąć przycisk „”, aby wyjąć cały pojemnik na wodę, otworzyć gumową zatyczkę i wlać wodę.
2. Nacisnąć przycisk „”, aby wysunąć pojemnik na wodę, otworzyć gumową zatyczkę i wlać wodę.

Rozwiązywanie problemów

W przypadku wystąpienia problemów z urządzeniem, należy sprawdzić rozdział „Co zrobić, gdy...” w pełnej wersji Instrukcji

użytkownika dostępnej w witrynie: www.ikea.com.

Tabela menu automatycznego

Wyświetlacz	Menu	Tryb lub temperatura	Czas	Rozgrzewanie wstępne
A01	Pieczone żeberka wołowe	 250°C	4 min	TAK
A02	Stek wołowy z czarnym pieprzem	 250°C	8 min	TAK
A03	Lekkie ciasto	 150°C	50 min	TAK
A04	Czerwone babeczki	 160°C	35 min	TAK
A05	Pieczone wieprzowe kotlety z kostką po francusku	 200°C	50 min	TAK
A06	Włoskie ciasto z owocami (20 cm)	 190°C	22 min	TAK

A07	Ptysie	 190°C	24 min	TAK
A08	Pieczony dorsz	 250°C	8 min	TAK
A09	Pieczone skrzydełka z kurczaka	 L1 230°C	25 min	TAK
A10	Pieczone żeberka wieprzowe	 L1 200°C	25 min	Brak
A11	Pieczona sajra	 L1 220°C	14 min	TAK
A12	Pieczony cały kurczak	 L1 200°C	45 min	TAK
A13	Pieczeń wieprzowa	 L1 180°C	50 min	TAK
A14	Kotlet jagnięcy po francusku	 L1 220°C	25 min	TAK
A15	Pieczone wieprzowe kotlety z kostką po francusku	 L1 230°C	80 min	Brak
A16	Sernik	 L1 160°C	55 min	TAK
A17	Placek z czekoladą i żurawiną	 L1 180°C	25 min	TAK
A18	Ciasto orzechowe	 L1 190°C	30 min	TAK

Dane techniczne

Dane techniczne

Wymiary (wewnętrzne)	Szerokość Wysokość Głębokość	503 mm 353 mm 386 mm
Powierzchnia blachy do pieczenia	1159 cm ²	
Górna grzałka	900 W	
Dolna grzałka	1500 W	
Grill	1300 W	
Pierścień	1800 W	
Łączna moc	3150 W	

Dane techniczne

Napięcie	220 – 240 V~
Częstotliwość	50 – 60 Hz
Liczba funkcji	14

Dane techniczne**Dane techniczne**

Wymiary (wewnętrzne)	Szerokość	503 mm
	Wysokość	353 mm
	Głębokość	386 mm
Powierzchnia blachy do pieczenia	1159 cm ²	
Górna grzałka	900 W	
Dolna grzałka	1500 W	
Grill	1300 W	
Pierścień	1800 W	
Łączna moc	3150 W	

Dane techniczne

Napięcie	220 – 240 V~
Częstotliwość	50 – 60 Hz
Liczba funkcji	14

Wydajność energetyczna

Informacje na temat produktu oraz karta informacyjna produktu*

Nazwa dostawcy	IKEA
Model	MÅGEBO 905-570-61
Wskaźnik wydajności energetycznej	76,9
Klasa wydajności energetycznej	A+
Zużycie energii przy standardowej ilości pieczonej żywności, tryb konwencjonalny	1,02 kWh
Zużycie energii przy standardowej ilości pieczonej żywności, tryb z termoobiegiem	0,65 kWh
Liczba komór	1
Źródło ciepła	Prąd elektryczny
Pojemność	72 l
Rodzaj piekarnika	Do zabudowy
Masa	43,5 kg
* Dla krajów Unii Europejskiej zgodnie z dyrektywami UE 65/2014 i 66/2014. Dla Białorusi w myśl STB 2478-2017, załącznik G; STB 2477-2017, załączniki A i B.	
Klasa wydajności energetycznej nie dotyczy Rosji.	
EN 60350-1 – domowe elektryczne urządzenia do gotowania – część 1: kuchenki, piekarniki, piekarniki parowe i grille – sposoby mierzenia wydajności.	

Gaminio aprašymas

Bendra apžvalga

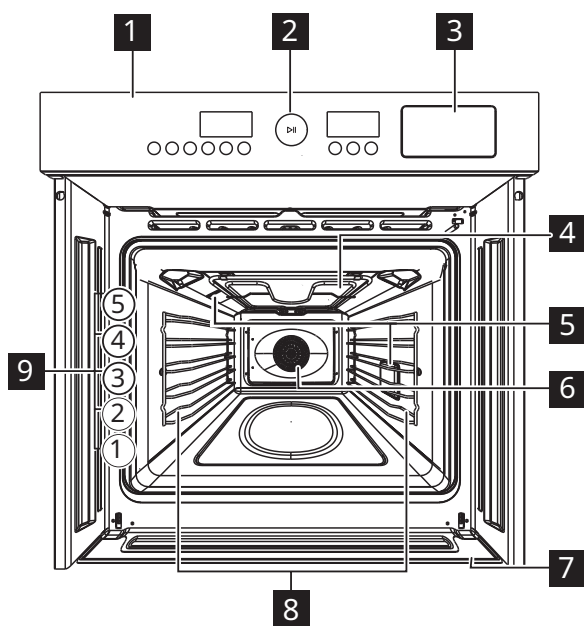

- 1 Valdymo skydelis
- 2 Nustatymo rankenėlė
- 3 Stalčius vandeniui
- 4 Groteles
- 5 Lempa
- 6 Ventiliatorius
- 7 Vandens surinktuvas
- 8 Nuimama lentynos atrama
- 9 Lentynos padėty

Valdymo skydelis

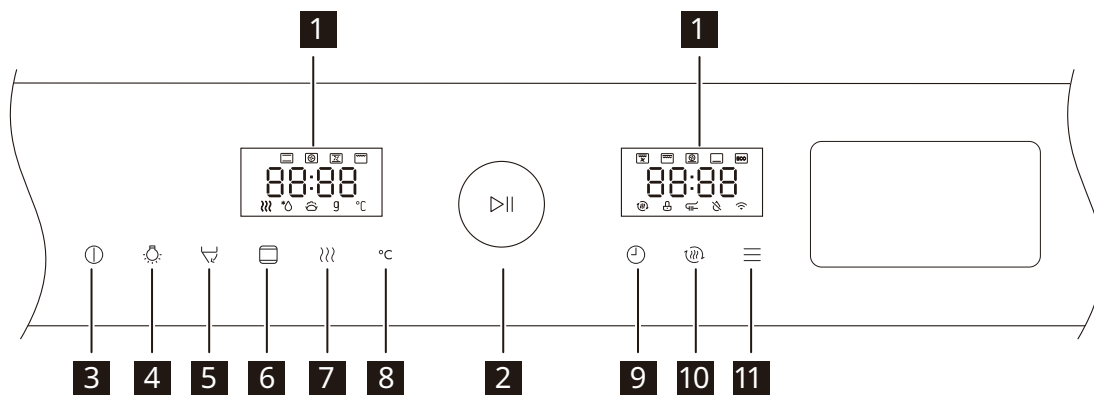

- 1 Ekranas
- 2 Rankenėlė
- 3 Atšaukti
- 4 Lempa
- 5 Dėžė vandeniui
- 6 Režimo pasirinkimas
- 7 Garas
- 8 Temperatūra
- 9 Laikas
- 10 Greitas pašildymas
- 11 Automatinis meniu

Ekranas

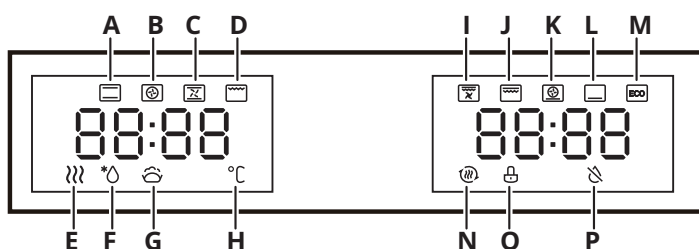

- | | |
|---|--------------------------|
| A. Įprastas | J. Dvigubas grilis |
| B. Konvekcija | K. Pica |
| C. Įprastas +
ventiliatorius | L. Dugno
kaitinimas |
| D. Grotelės | M. EKO |
| E. Garas | N. Greitas
pašildymas |
| F. Atšildymas | O. Apsauga nuo
vaikų |
| G. Tešlos kildinimas | P. Trūksta
vandens |
| H. Temperatūra | |
| I. Dvigubas grilis ir
ventiliatorius | |

Meniu apžvalga

- | | | |
|--|--|---|
| | Įprastas | Iškepti dideli tortai. |
| | Konvekcija | Ypač tinka kepatant maistą, kurio spalva turi būti tolygi. |
| | Įprastas +
ventiliatorius | Ventiliatorių ir kaitinimo elementų derinys užtikrina tolygesnį šilumos skvarbą, todėl sutaupoma iki 30–40 % energijos. |
| | Grilis | Kepkite nedidelius maisto kiekius. |
| | Dvigubas grilis ir
ventiliatorius | Kepsninėje kepkite plokščią maistą. |
| | Dvigubas grilis | Kepkite nedidelius plokščio maisto kiekius. |
| | Pica | Kepta pica. |
| | Dugno kaitinimas | Nuspalvina plokščio maisto apatinę dalį. |
| | EKO | Energiją taupančiam maisto gaminimui. |
| | Atšildymas | Atšildykite šaldytus maisto produktus. |
| | Tešlos kildinimas | Rauginta tešla arba jogurtas. |
| | Džiovinimo funkcija | Jis naudojamas krosnies kamerai išdžiovinti ir užkirsti kelią bakterijų dauginimuisi. |
| | Kalkių šalinimas | Į vandens dėžę įpilkite citrinos rūgšties, kad pašalintumėte apnašas iš vamzdžio. |

Gaminimo režimas su garų pagalbine funkcija

- | | | | | | |
|--|------------|--|------------------|--|---------------------------|
| | Įprastas | | Grilis | | Įprastas + ventiliatorius |
| | Konvekcija | | Dugno kaitinimas | | Valymas garais |

Naudojama dėžė vandeniui

Dėdami dėžę vandeniui atgal į talpyklos vietą, įsitikinkite, kad vandens talpykla įstumta iki galo.

Po gaminimo išpilkite vandens dėžėje likusį vandenį ir sausai nušluostykite, kad nesidaugintų bakterijos.

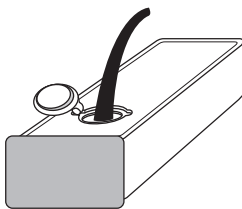

Kai naudojate garų pagalbinę funkciją ir automatinį meniu, į vandens talpyklą iš anksto įpilkite išvalyto vandens.

1 būdas

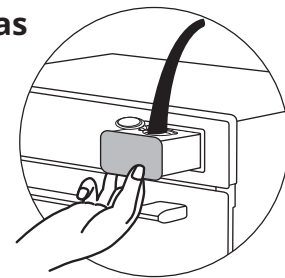

2 būdas









1. Spustelėkite mygtuką „“, kad visiškai ištrauktumėte dėžę vandeniui, atidarytumėte guminį žiedą ir įpiltumėte vandens.
2. Spustelėkite mygtuką „“, kad iššoktų dėžė vandeniui, atidarykite guminį žiedą ir įpilkite vandens.

Trikčių šalinimas

Jei susidūrėte su problema, susijusia su prietaisu, peržiūrėkite pilnos versijos

naudotojo vadovo skyrių „Ką daryti...“ svetainėje: www.ikea.com.

Automatinio meniu lapas

Ekranas	Meniu	Režimas arba temperatūra	Laikas	Pašildymas
A01	Skrudinti jautienos šonkauliai	 250 °C	4 min	TAIP
A02	Jautienos kepsnys su juodaisiais pipirais	 250 °C	8 min	TAIP
A03	Šifoninis pyragas	 150 °C	50 min	TAIP
A04	Raudonas velvetinis keksiukas	 160 °C	35 min	TAIP
A05	Prancūziškas kiaulienos kepsnys	 200 °C	50 min	TAIP
A06	Itališkas vaisių pyragas (8 colių)	 190 °C	22 min	TAIP
A07	Kremo pyragas	 190 °C	24 min	TAIP

A08	Skrudinta menkė	 250 °C	8 min	TAIP
A09	Skrudinti vištienos sparneliai	 L1 230 °C	25 min	TAIP
A10	Skrudinti kiaulienos šonkauliai	 L1 200 °C	25 min	NE
A11	Skrudinta lydekinė skumbrė	 L1 220 °C	14 min	TAIP
A12	Kepta višta	 L1 200 °C	45 min	TAIP
A13	Kiaulienos kepsnys	 L1 180 °C	50 min	TAIP
A14	Prancūziškas avienos kepsnys	 L1 220 °C	25 min	TAIP
A15	Prancūziškai kepta kiaulienos karka	 L1 230 °C	80 min	NE
A16	Sūrio pyragas	 L1 160 °C	55 min	TAIP
A17	Šokoladinė spanguolių duona	 L1 180 °C	25 min	TAIP
A18	Riešutų duona	 L1 190 °C	30 min	TAIP

Techniniai duomenys

Techniniai duomenys

Matmenys (vidiniai)	Plotis Aukštis Ilgis	503 mm 353 mm 386 mm
Kepimo skardos plotas	1159 cm ²	
Viršutinis kaitinimo elementas	900 W	
Apatinis kaitinimo elementas	1500 W	
Grotelės	1300 W	
Žiedas	1800 W	
Viso	3150 W	

Techniniai duomenys

Įtampa	220–240V~
Dažnis	50–60 Hz
Funkcijų kiekis	14

Techniniai duomenys

Techniniai duomenys

Matmenys (vidiniai)	Plotis Aukštis Ilgis	503 mm 353 mm 386 mm
Kepimo skardos plotas	1159 cm ²	
Viršutinis kaitinimo elementas	900 W	
Apatinis kaitinimo elementas	1500 W	
Grotelės	1300 W	
Žiedas	1800 W	
Viso	3150 W	

Techniniai duomenys

Įtampa	220–240V~
Dažnis	50–60 Hz
Funkcijų kiekis	14

Energijos efektyvumas

Informacija apie produktą ir produkto informacinis lapas*

Tiekėjo pavadinimas	IKEA
Modelio identifikatorius	MÅGEBO 905-570-61
Energijos vartojimo efektyvumo indeksas	76,9
Energijos efektyvumo klasė	A+
Energijos suvartojimas su standartine apkrova, įprastinis režimas	1,02 kWh
Energijos suvartojimas esant standartinei apkrovai, ventiliatoriaus priverstinis režimas	0,65 kWh
Kamerų skaičius	1
Kaitinimo šaltinis	Elektra
Tūris	72 l
Krosnelės tipas	Įmontuojama krosnelė
Masė	43,5 kg
* Europos Sąjungai pagal ES reglamentus 65/2014 ir 66/2014. Baltarusijos Respublikai pagal STB 2478-2017 G priedą; STB 2477-2017 A ir B priedus.	
Energijos vartojimo efektyvumo klasė Rusijoje netaikoma.	
EN 60350-1. Buitiniai elektriniai maisto ruošimo prietaisai. 1 dalis: Krosnelės, orkaitės, garų krosnelės ir kepsninės. Eksploatacinių savybių matavimo metodai.	

Toote kirjeldus

Üldine ülevaade

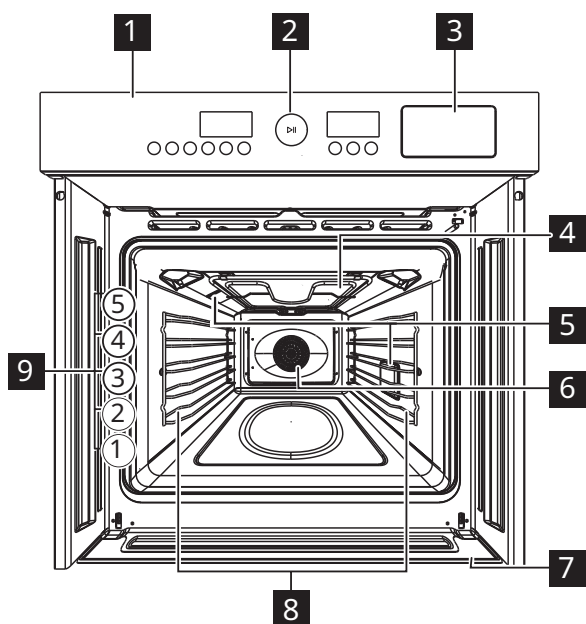

- 1 Juhtpaneel
- 2 Reguleerimisnupp
- 3 Veesahtel
- 4 Grill
- 5 Lamp
- 6 Ventilaator
- 7 Veekogumisanum
- 8 Eemaldatav riulitugi
- 9 Riulite asendid

Juhtpaneel

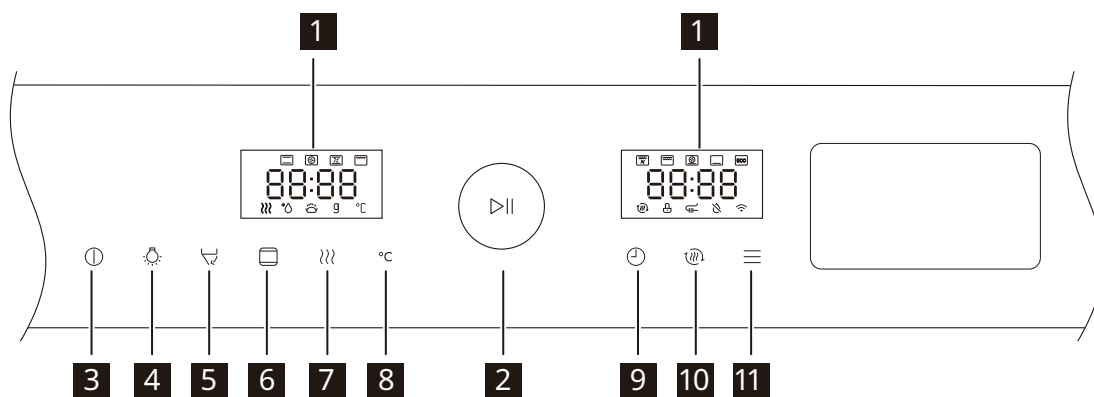

- 1 Ekraan
- 2 Nupp
- 3 Tühista
- 4 Lamp
- 5 Veekarp
- 6 Režiimivalik
- 7 Aur
- 8 Temperatuur
- 9 Aeg
- 10 Kiire eelsoojendus
- 11 Automaatne menüü

Ekraan

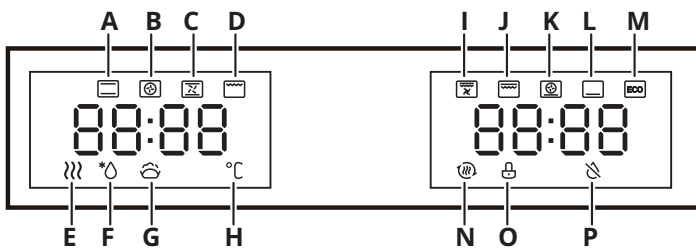

- | | |
|---------------------------------|--------------------------|
| A. Tavapärane | J. Topeltgrill |
| B. Konvektsioon | K. Pitsa |
| C. Tavapärane +
ventilaator | L. Alt
kuumutamine |
| D. Grill | M. ECO |
| E. Aur | N. Kiire
eelsoojendus |
| F. Sulatamine | O. Lapsekindel |
| G. Taigna küpsetamine | P. Veetase on
madal |
| H. Temperatuur | |
| I. Topeltgrill +
ventilaator | |

Menüüde ülevaade

- | | | |
|--|--------------------------------------|---|
| | Tavapärane | Suured küpsetatud koogid. |
| | Konvektsioon | Sobib eriti hästi toidu küpsetamiseks, mis peab olema ühtlase tooniga. |
| | Tavapärane +
ventilaator | Ventilaatorite ja kütteelementide kombinatsioon tagab ühtlasema soojuse mõju, säästes kuni 30–40% energias. |
| | Grill | Väikestes kogustes toidu küpsetamine. |
| | Topeltgrill +
ventilaator | Lameda kujuga toidu grillimine. |
| | Topeltgrill | Väikestes kogustes lameda kujuga toidu küpsetamine. |
| | Pitsa | Pitsa küpsetamine. |
| | Alt kuumutamine | Lameda kujuga toidu põhjale värvi andmiseks. |
| | ECO | Energiasäästlik küpsetamine. |
| | Sulatamine | Külmutatud toidu sulatamine. |
| | Taigna küpsetamine | Fermentitud tainas või jogurt. |
| | Kuivatusfunktsioon | Kasutatakse ahjukambri kuivatamiseks ja bakterikasvu takistamiseks. |
| | Katlakivi
eemaldamine | Lisades veekarpi sidrunhapet, saate eemaldada torust katlakivi. |

Auruga küpsetamise režiim

- | | | | | | |
|--|---------------------|--|------------------------|--|-------------------------------|
| | Tavapärane | | Grill | | Tavapärane+ventilaator |
| | Konvektsioon | | Alt kuumutamine | | Aurupuhastus |

Veekarbi kasutamine

Kui asetate veekarbi tagasi pesasse, veenduge, et veepaak oleks lõpuni sisse lükatud. Pärast toidu valmimist valage veekarpi jäänud vesi ära ja pühkige karp kuivaks, et vältida bakterikasvu.

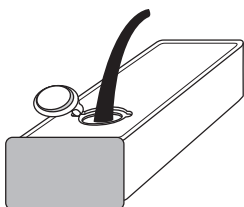

Kui kasutate auruga küpsetamise funktsiooni ja automaatset menüüd, lisage varem puhastatud vesi veepaaki.

tee 1

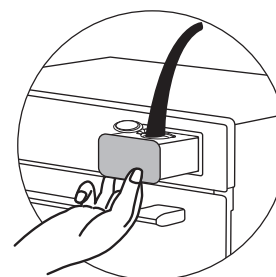

tee 2











1. Klõpsake terve veekarbi väljavõtmiseks klahvi „“, avage kummirõngas ja lisage vett.
2. Klõpsake veekarbi väljalükkamiseks klahvi „“, avage kummirõngas ja lisage vett.











Tõrkeotsing

Kui teil tekib kodumasinaga probleeme, vaadake jaotist „Kuidas käituda, kui“

veebisaidil www.ikea.com saadaval olevast täispikkuses kasutusjuhendist.

Automaatsete menüüde leht

Ekraan	Menüü	Režiim või temperatuur	Aeg	Eelsoojendus
A01	Rõstitud veiseribid	 250°C	4 min	JAH
A02	Veisesteik musta pipraga	 250°C	8 min	JAH
A03	Šefiirikook	 150°C	50 min	JAH
A04	Punane sametkook	 160°C	35 min	JAH
A05	Prantsuse seapraad	 200°C	50 min	JAH
A06	Itaalia puuviljakook (8 tolli)	 190°C	22 min	JAH
A07	Kreemikook	 190°C	24 min	JAH
A08	Rõstitud tursk	 250°C	8 min	JAH

A09	Röstitud kanatiivad	 L1 230°C	25 min	JAH
A10	Röstitud searibid	 L1 200°C	25 min	EI
A11	Röstitud makrellhaug	 L1 220°C	14 min	JAH
A12	Röstitud terve kana	 L1 200°C	45 min	JAH
A13	Röstitud siga	 L1 180°C	50 min	JAH
A14	Prantsuse lambalihakarbonaad	 L1 220°C	25 min	JAH
A15	Prantsuse seapraad	 L1 230°C	80 min	EI
A16	Juustukook	 L1 160°C	55 min	JAH
A17	Šokolaadi-jõhvikaleib	 L1 180°C	25 min	JAH
A18	Pähklileib	 L1 190°C	30 min	JAH

Tehnilised andmed

Tehnilised andmed

Mõõtmed (sisemus)	Laius Kõrgus Sügavus	503 mm 353 mm 386 mm
Küpsetusaluse pindala	1159 cm ²	
Ülemine soojenduselement	900 W	
Alumine soojenduselement	1500 W	
Grill	1300 W	
Rõngas	1800 W	
Koguvõimsus	3150 W	

Tehnilised andmed

Pinge	220 – 240 V~
Sagedus	50 – 60 Hz
Funktsioonide arv	14

Tehnilised andmed**Tehnilised andmed**

Mõõtmed (sisemus)	Laius Kõrgus Sügavus	503 mm 353 mm 386 mm
Küpsetusaluse pindala	1159 cm ²	
Ülemine sojenduselement	900 W	
Alumine sojenduselement	1500 W	
Grill	1300 W	
Rõngas	1800 W	
Koguvõimsus	3150 W	

Tehnilised andmed

Pinge	220 – 240 V~
Sagedus	50 – 60 Hz
Funktsioonide arv	14

Energiatõhusus

Tooteinformatsioon ja toote teabeleht*

Tarnija nimi	IKEA
Mudeli tähis	MÅGEBO 905-570-61
Energiatõhususe indeks	76,9
Energiasäästuklass	A+
Energiatarbimine standardkoormusel, tavarežiim	1,02 kWh
Energiatarbimine standardkoormusel, ventilaatoriga sundõhu režiim	0,65 kWh
Küpsetuskambrite arv	1
Soojusallikas	Elekter
Maht	72 l
Ahju tüüp	Sisseehitatud ahi
Kaal	43,5 kg
* Euroopa Liidus määruste EL 65/2014 ja 66/2014 kohaselt. Valgevene Vabariigis standardite STB 2478-2017, liide G, STB 2477-2017, lisade A ja B kohaselt.	
Energiaklass ei kehti Venemaa puhul.	
EN 60350-1 – Kodumajapidamises kasutatavad elektrilised toiduvalmistusseadmed. Osa 1: Pliidid, ahjud, auruahjud ja grillid. Toimivuse mõõtemetodid.	

Izstrādājuma apraksts

Vispārējs pārskats

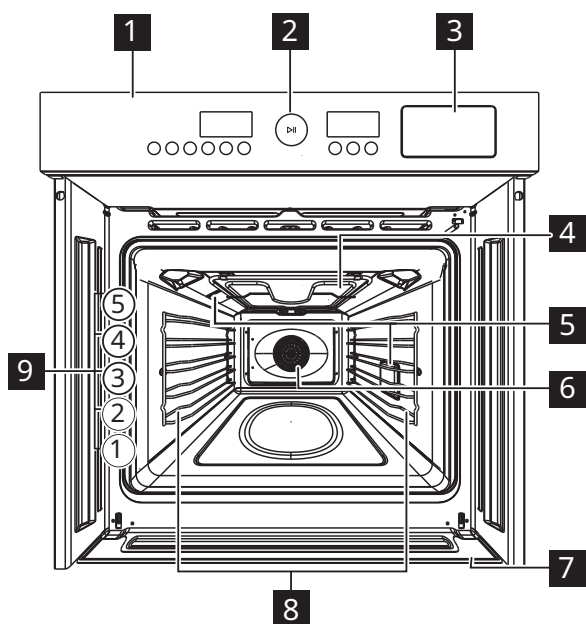

- 1 Vadības panelis
- 2 Poga iestatīšanai
- 3 Ūdens atvilktnē
- 4 Grils
- 5 Lampa
- 6 Ventilators
- 7 Ūdens kolektors
- 8 Plaukta balsts, noņemams
- 9 Plauktu pozīcijas

Vadības panelis

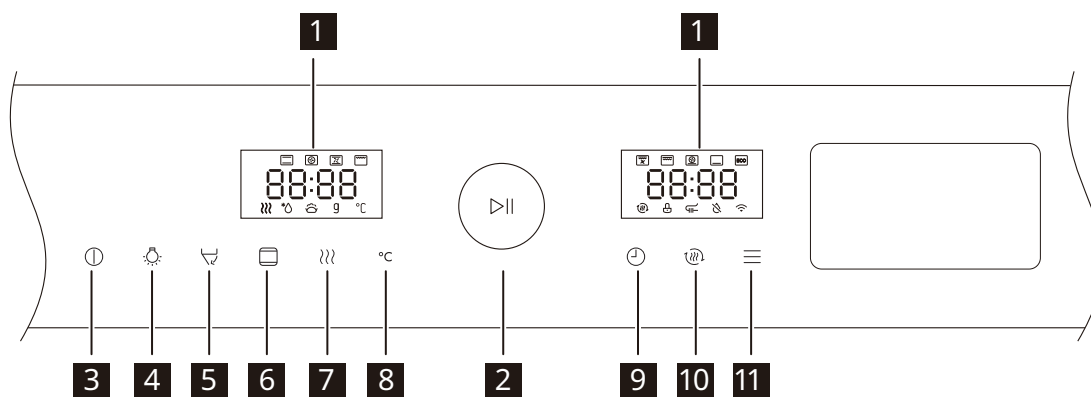

- 1 Displejs
- 2 Grozāmpoga
- 3 Atcelt
- 4 Lampa
- 5 Ūdens tvertne
- 6 Režīma izvēle
- 7 Tvaiks
- 8 Temperatūra
- 9 Laiks
- 10 Strauja iepriekšējā uzkarsēšana
- 11 Automātiskas darbības izvēle

Displejs

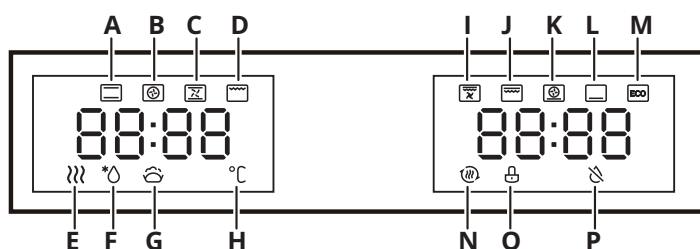

- | | |
|-------------------------------------|---------------------------------|
| A. Parasts | J. Divkārša grilēšana |
| B. Konvekcija | K. Pica |
| C. Parasts + ventilators | L. Apakšējā karsēšana |
| D. Grils | M. EKO |
| E. Tvaiks | N. Ātra iepriekšējā uzkaršēšana |
| F. Atkausēšana | O. Bērnu aizsardzība |
| G. Mīklas rūdīšana | P. Ūdens trūkums |
| H. Temperatūra | |
| I. Divkārša grilēšana + ventilators | |

Izvēlņu pārskats

- | | | |
|--|---|---|
| | Parasts | Lielas ceptas kūkas. |
| | Konvekcija | Īpaši piemērots tādu ēdienu cepšanai, kuriem nepieciešams vienmērīgs krāsojums. |
| | Parasts + ventilators | Ventilatoru un sildelementu kombinācija nodrošina vienmērīgāku karstuma iespiešanos, ietaupot līdz pat 30 - 40 % enerģijas. |
| | Grils | Mazu ēdiena daudzumu cepšana. |
| | Divkārša grilēšana + ventilators | Plakanu pārtikas produktu grilēšana. |
| | Divkārša grilēšana | Plakanu pārtikas produktu cepšana mazā daudzumā. |
| | Pica | Picas cepšana. |
| | Apakšējā karsēšana | Krāsojums plakanu pārtikas produktu apakšpusēm. |
| | EKO | Energoekonomiskai ēdienu gatavošanai. |
| | Atkausēšana | Sasaldētas pārtikas atkausēšana. |
| | Mīklas rūdīšana | Mīklas vai jogurta raudzēšana. |
| | Žāvēšanas funkcija | To izmanto cepeškrāsns kameras žāvēšanai un baktēriju augšanas novēršanai. |
| | Atkaļķošana | Pievienojot citronskābi ūdens tvertnē, lai noņemtu kaļķa nogulsnes caurulē. |

Gatavošanas režīms ar tvaika palīgfunkciju

- | | | | | | |
|--|-------------------|--|---------------------------|--|------------------------------|
| | Parasts | | Grils | | Parasts + ventilators |
| | Konvekcija | | Apakšējā karsēšana | | Tīrīšana ar tvaiku |

Ūdens tvertnes lietošana

Ievietojot ūdens tvertni atpakaļ tvertnes nodalījumā, iebīdiet ūdens tvertni līdz galam. Pēc ēdiena pagatavošanas izlejiet visu ūdens tvertnē atlikušo ūdeni un izslaukiet tvertni sausu, lai nepieļautu baktēriju augšanu.

Ja izmantojat tvaika palīgfunkciju un automātisko izvēlni, iepriekš piepildiet ūdens tvertni ar attīrītu ūdeni.

1. veids

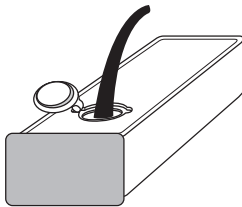

2. veids

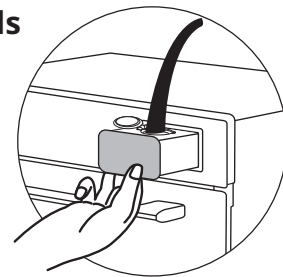

1. Nospiediet taustiņu "☑", lai izņemtu visu ūdens tvertni, atveriet gumijas gredzenu un ielejiet ūdeni.
2. Nospiediet taustiņu "☑", lai uzpildītu ūdens tvertni, atveriet gumijas gredzenu un ielejiet ūdeni.

Problēmu novēršana

Ja radusies problēma ar ierīci, skatiet nodaļu "Ko darīt, ja..." Lietotāja

rokasgrāmatas pilnajā versijā, kas pieejama www.ikea.com.

Automātisko izvēlņu lapa

Displejs	Izvēlne	Režīms vai temperatūra	Laiks	Iepriekšēja uzkarsēšana
A01	Ceptas liellopa ribiņas	250 °C	4 min	JĀ
A02	Liellopu gaļas steiks ar melnajiem pipariem	250 °C	8 min	JĀ
A03	Šifona kūka	150 °C	50 min	JĀ
A04	Kūciņa "Sarkanais samts"	160 °C	35 min	JĀ
A05	Cepta cūkgaļas karbonāde franču gaumē	200 °C	50 min	JĀ
A06	Augļu pīrāgs itāļu gaumē (8 collas)	190 °C	22 min	JĀ

A07	Vēja kūka	 190 °C	24 min	JĀ
A08	Cepta menca	 250 °C	8 min	JĀ
A09	Cepti cāļu spārniņi	 L1 230 °C	25 min	JĀ
A10	Ceptas cūku ribiņas	 L1 200 °C	25 min	NO
A11	Cepta saira	 L1 220 °C	14 min	JĀ
A12	Cepts vesels cālis	 L1 200 °C	45 min	JĀ
A13	Cepta cūkgaļa	 L1 180 °C	50 min	JĀ
A14	Jēra karbonāde franču gaumē	 L1 220 °C	25 min	JĀ
A15	Cepts cūkas stilbs franču gaumē	 L1 230 °C	80 min	NO
A16	Siera kūka	 L1 160 °C	55 min	JĀ
A17	Šokolādes un dzērveņu kēkss	 L1 180 °C	25 min	JĀ
A18	Riekstu kēkss	 L1 190 °C	30 min	JĀ

Tehniskie dati

Tehniskie dati

Izmēri (iekšējie)	Platums Augstums Dziļums	503 mm 353 mm 386 mm
Cepšanas paplātes laukums	1159 cm ²	
Augšējais sildelements	900 W	
Apakšējais sildelements	1500 W	
Grils	1300 W	
Gredzens	1800 W	
Kopējā jauda	3150 W	

Tehniskie dati

Spriegums	220 - 240 V~
Frekvence	50 - 60 Hz
Funkciju skaits	14

Tehniskie dati**Tehniskie dati**

Izmēri (iekšējie)	Platums Augstums Dziļums	503 mm 353 mm 386 mm
Cepšanas paplātes laukums	1159 cm ²	
Augšējais sildelements	900 W	
Apakšējais sildelements	1500 W	
Grils	1300 W	
Gredzens	1800 W	
Kopējā jauda	3150 W	

Tehniskie dati

Spriegums	220 - 240 V~
Frekvence	50 - 60 Hz
Funkciju skaits	14

Energoefektivitāte

Izstrādājuma informācija un izstrādājuma informācijas lapa*

Piegādātāja nosaukums	IKEA
Modeļa identifikācija	MÅGEBO 905-570-61
Energoefektivitātes indekss	76,9
Energoefektivitātes klase	A+
Enerģijas patēriņš standarta slodzē parastā režīmā	1,02 kWh
Enerģijas patēriņš standarta slodzē ventilatora pastiprinājuma režīmā	0,65 kWh
Kameru skaits	1
Karstuma avots	Elektrība
Tilpums	72 l
Cepeškrāsns veids	Iebūvēta cepeškrāsns
Masa	43,5 kg
* Eiropas Savienībai saskaņā ar ES regulām 65/2014 un 66/2014. Baltkrievijas Republikai saskaņā ar STB 2478-2017 G pielikumu; STB 2477-2017, A un B pielikumiem.	
Energoefektivitātes klase nav piemērojama Krievijai.	
EN 60350-1 – Elektriskās mājsaimniecības ierīces ēdiena gatavošanai – 1. daļa: Plītis, cepeškrāsns, tvaika cepeškrāsns un grili – Veiktspējas mērīšanas metodes.	

Описание изделия

Общий обзор

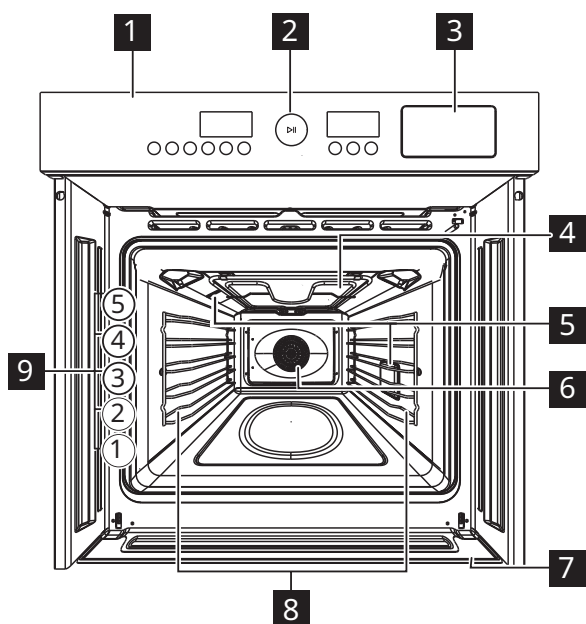

- 1 Панель управления
- 2 Ручка для настройки
- 3 Отсек для воды
- 4 Гриль
- 5 Лампа
- 6 Вентилятор
- 7 Водосборник
- 8 Съёмная опора полки
- 9 Позиции полок

Панель управления

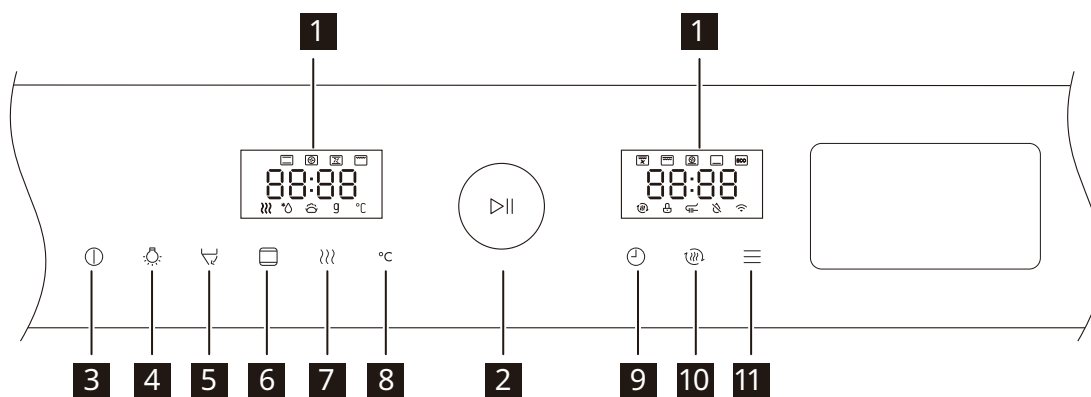





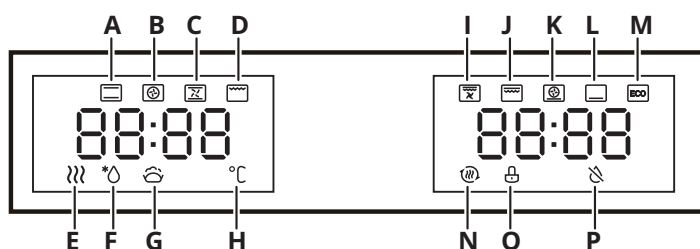







- 1 Индикация на дисплее
- 2 Ручка
- 3 Отмена
- 4 Лампа
- 5 Бачок для воды
- 6 Выбор режима
- 7 Пар
- 8 Температура
- 9 Время
- 10 Быстрый предварительный нагрев
- 11 Автоматическая программа

Индикация на дисплее



- A. Режим конвекции
- B. Конвекция
- C. Конвекция + вентилятор
- D. Гриль
- E. Пар
- F. Разморозка
- G. Расстойка теста
- H. Температура
- I. Двойной гриль + вентилятор
- J. Двойной гриль
- K. Пицца
- L. Разогрев снизу
- M. Экорезим
- N. Быстрый предварительный нагрев
- O. Защита от доступа детей
- P. Недостаток воды

Обзор меню

-  **Режим конвекции** Большие пироги.
-  **Конвекция** Этот режим особенно подходит для выпечки продуктов, которые должны быть равномерно подрумянены.
-  **Конвекция + вентилятор** Комбинация вентиляторов и нагревательных элементов обеспечивает более равномерное проникновение тепла, экономя от 30 до 40% энергии.
-  **Гриль** Этот режим используется для выпечки небольшого количества продуктов.
-  **Двойной гриль + вентилятор** Барбекю/плоские продукты.
-  **Двойной гриль** Этот режим используется для выпечки небольшого количества плоских продуктов.
-  **Пицца** Запеченная пицца.
-  **Разогрев снизу** Это режим позволяет подрумянить нижнюю часть плоских продуктов.
-  **Экорезим** Этот режим используется для энергосберегающего приготовления пищи.
-  **Разморозка** Этот режим используется для разморозки замороженных продуктов.
-  **Расстойка теста** Этот режим используется для приготовления продуктов на основе заквашенного теста или йогурта.
-  **Функция сушки** Этот режим используется для сушки камеры печи и предотвращения размножения бактерий.
-  **Удаление накипи** Добавляя лимонную кислоту в бачок для воды, можно удалить накипь в трубке.

Режим приготовления с функцией подачи пара

-  **Режим конвекции**
-  **Гриль**
-  **Конвекция + вентилятор**
-  **Конвекция**
-  **Разогрев снизу**
-  **Очистка паром**

Чтобы загрузить полную версию руководства, посетите веб-сайт www.ikea.com

Использование бачка для воды

При установке бачка для воды обратно в его отсек убедитесь, что он вставлен до упора.

После приготовления пищи слейте воду, оставшуюся в бачке для воды, и вытрите его насухо, чтобы предотвратить размножение бактерий.

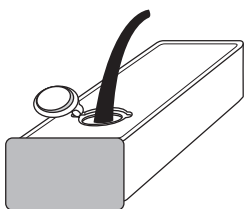

При использовании функций подачи пара и автоматической программы заранее добавьте очищенную воду в бачок для воды.

Способ 1

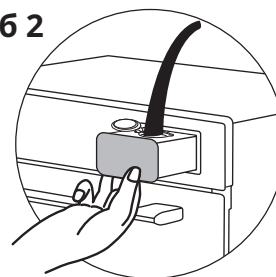

Способ 2



1. Нажмите кнопку , чтобы полностью извлечь бачок для воды, откройте резиновую пробку и добавьте воду.
2. Нажмите кнопку , чтобы выдвинуть бачок для воды, откройте резиновую пробку и добавьте воду.

Устранение неисправностей

Если у вас возникнут проблемы с вашим устройством, прочитайте главу «Что делать, если...» в полной версии

Руководства пользователя на странице www.ikea.com.

Список автоматических программ

Индикация на дисплее	Меню	Режим или температура	Время	Предварительный нагрев
A01	Жареные говяжьи ребрышки	 250 °C	4 мин.	ДА
A02	Бифштекс из говядины с черным перцем	 250 °C	8 мин.	ДА
A03	Шифоновый бисквит	 150 °C	50 мин.	ДА
A04	Торт «красный бархат»	 160 °C	35 мин.	ДА
A05	Жареная свиная отбивная по-французски	 200 °C	50 мин.	ДА
A06	Итальянский фруктовый пирог (8 дюймов)	 190 °C	22 мин.	ДА

A07	Слойка с кремом	 190 °C	24 мин.	ДА
A08	Жареная треска	 250 °C	8 мин.	ДА
A09	Жареные куриные крылышки	 L1 230 °C	25 мин.	ДА
A10	Жареные свиные ребрышки	 L1 200 °C	25 мин.	НЕТ
A11	Жареная сайра	 L1 220 °C	14 мин.	ДА
A12	Жареная курица целиком	 L1 200 °C	45 мин.	ДА
A13	Жареная свинина	 L1 180 °C	50 мин.	ДА
A14	Отбивная из баранины по-французски	 L1 220 °C	25 мин.	ДА
A15	Жареные свиные рульки по-французски	 L1 230 °C	80 мин.	НЕТ
A16	Чизкейк	 L1 160 °C	55 мин.	ДА
A17	Шоколадный клюквенный хлеб	 L1 180 °C	25 мин.	ДА
A18	Ореховый хлеб	 L1 190 °C	30 мин.	ДА

Технические данные

Технические данные

Размеры (внутренние)	Ширина Высота Глубина	503 мм 353 мм 386 мм
Площадь противня	1159 см ²	
Верхний нагревательный элемент	900 Вт	
Нижний нагревательный элемент	1500 Вт	
Гриль	1300 Вт	
Кольцевой нагревательный элемент	1800 Вт	
Общая мощность	3150 Вт	

Технические данные

Напряжение	220–240 В перем. тока
Частота	50–60 Гц
Количество функций	14

Чтобы загрузить полную версию руководства, посетите веб-сайт www.ikea.com

Технические данные**Технические данные**

Размеры (внутренние)	Ширина	503 мм
	Высота	353 мм
	Глубина	386 мм
Площадь противня	1159 см ²	
Верхний нагревательный элемент	900 Вт	
Нижний нагревательный элемент	1500 Вт	
Гриль	1300 Вт	
Кольцевой нагревательный элемент	1800 Вт	
Общая мощность	3150 Вт	

Технические данные

Напряжение	220–240 В перем. тока
Частота	50–60 Гц
Количество функций	14

Энергоэффективность

Таблица сведений о приборе*

Наименование компании-поставщика	IKEA
Идентификация модели	MÅGEBO 905-570-61
Коэффициент энергоэффективности	76,9
Класс энергоэффективности	A+
Энергопотребление при стандартной нагрузке в нормальном режиме	1,02 кВт-ч
Энергопотребление при стандартной нагрузке в режиме с принудительной вентиляцией	0,65 кВт-ч
Количество камер	1
Источник тепла	Электричество
Объем	72 л
Тип печи	Встроенная духовая печь
Масса	43,5 кг
* Для Европейского Союза данные соответствуют Регламентам ЕС 65/2014 и 66/2014. Для Республики Беларусь данные соответствуют СТБ 2478-2017, приложение Г и СТБ 2477-2017, приложения А и Б.	
Для России класс энергоэффективности не применим.	
EN 60350-1 — Бытовые электроприборы для приготовления пищи — часть 1: плиты, духовки, паровые печи и грили — методы измерения производительности.	

Popis spotřebiče

Všeobecný přehled

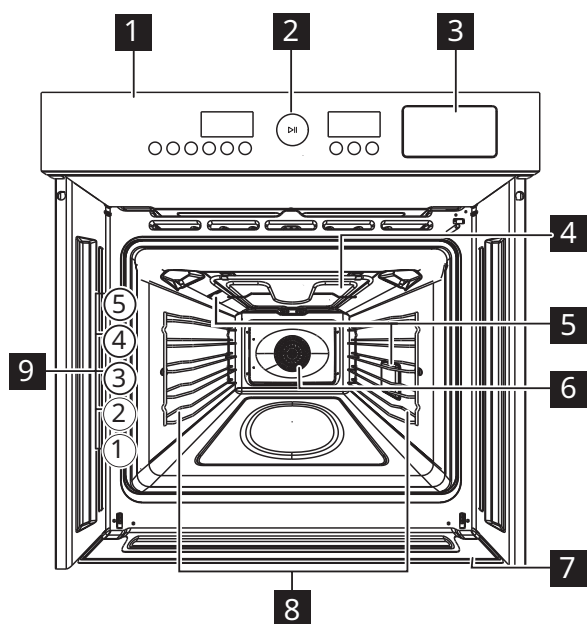

- 1 Ovládací panel
- 2 Knoflík pro nastavení
- 3 Zásuvka na vodu
- 4 Gril
- 5 Světlo
- 6 Ventilátor
- 7 Sběrač vody
- 8 Podpěra police, odnímatelná
- 9 Pozice v policích

Ovládací panel

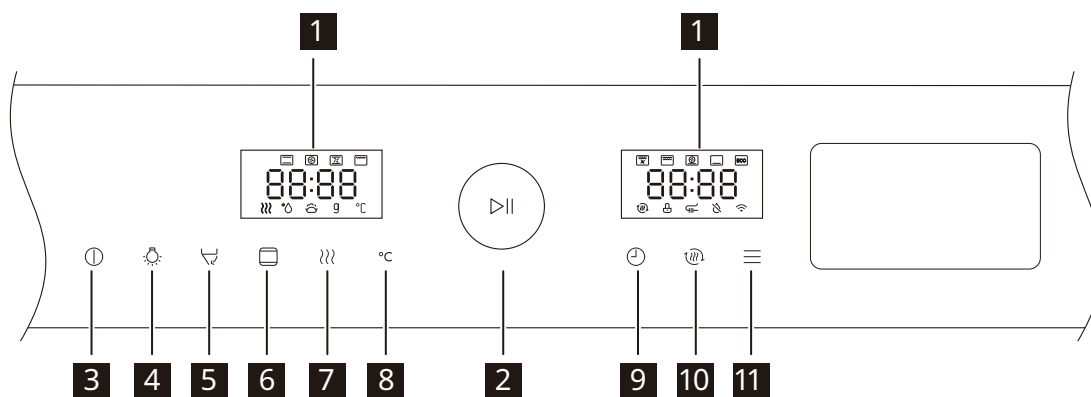

- 1 Displej
- 2 Knoflík
- 3 Zrušit
- 4 Světlo
- 5 Zásobník na vodu
- 6 Výběr režimu
- 7 Pára
- 8 Teplota
- 9 Čas
- 10 Rychlé předeheřtí
- 11 Automatická nabídka

Displej

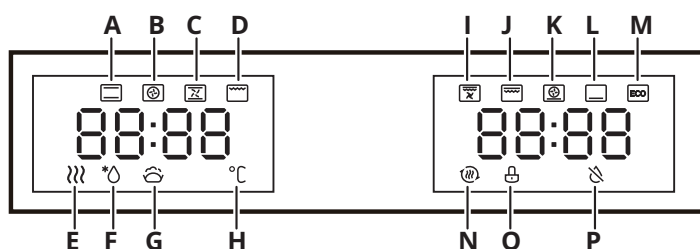

- | | |
|---------------------------------|-----------------------|
| A. Tradiční | J. Dvojitý gril |
| B. Konvekční | K. Pizza |
| C. Tradiční + ventilátor | L. Spodní ohřev |
| D. Gril | M. ECO |
| E. Pára | N. Rychlé
přehřátí |
| F. Rozmrazování | O. Dětská pojistka |
| G. Kynutí těsta | P. Nedostatek
vody |
| H. Teplota | |
| I. Dvojitý gril +
ventilátor | |

Přehled nabídek

- | | | |
|--|------------------------------------|---|
| | Tradiční | Slouží k pečení velkých dortů a koláčů. |
| | Konvekční | To je vhodné zejména pro pečení pokrmů, které mají být rovnoměrně zbarvené. |
| | Tradiční+ventilátor | Kombinace ventilátorů a topných těles zajišťuje rovnoměrnější pronikání tepla, čímž se ušetří až 30–40 % energie. |
| | Gril | Slouží k pečení malých množství potravin. |
| | Dvojitý gril + ventilátor | Slouží ke grilování plochých potravin. |
| | Dvojitý gril | Slouží k pečení malých množství plochých potravin. |
| | Pizza | Slouží k pečení pizza. |
| | Spodní ohřev | Slouží ke zbarvení spodku plochých potravin. |
| | ECO | Slouží k energeticky úspornému vaření. |
| | Rozmrazování | Slouží k rozmrazování zmrazených potravin. |
| | Kynutí těsta | Používá se pro kynuté těsto nebo jogurt. |
| | Funkce sušení | Používá se k vysušení komory trouby a k zabránění růstu bakterií. |
| | Odstraňování vodního kamene | Přidáním kyseliny citronové do zásobníku na vodu odstraní v trubkách vodní kámen. |

Režim přípravy jídla s funkcí parní asistence

- | | | | | | |
|--|------------------|--|---------------------|--|----------------------------|
| | Tradiční | | Gril | | Tradiční+ventilátor |
| | Konvekční | | Spodní ohřev | | Čištění párou |

Používání zásobníku na vodu

Při vkládání zásobníku na vodu zpět do prostoru pro zásobník se ujistěte, že je zásobník na vodu zcela zasunutý.

Po přípravě jídla vylijte veškerou vodu, která v zásobníku na vodu zůstala, a vytřete ho do sucha, abyste zabránili množení bakterií.

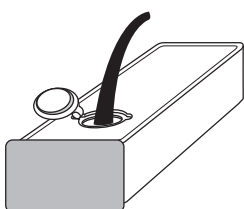

Při použití funkce parní asistence a automatické nabídky přidejte předem do zásobníku na vodu vyčištěnou vodu.

způsob 1

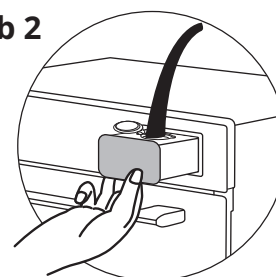

způsob 2



1. Klepnutím na tlačítko „“ vyjměte celý zásobník na vodu, otevřete gumový uzávěr a přidejte vodu.
2. Klepnutím na tlačítko „“ vysuňte zásobník na vodu, otevřete gumový uzávěr a přidejte vodu.

Řešení potíží

Pokud se spotřebičem nastane nějaký problém, podívejte se do kapitoly „Co dělat, když...“ v plné verzi návodu k obsluze, která je k dispozici na webu: www.ikea.com.

Tabulka automatických nabídek

Displej	Nabídka	Režim nebo teplota	Čas	Předehřívání
A01	Pečená hovězí žebírka	 250 °C	4 min	ANO
A02	Hovězí steak s černým pepřem	 250 °C	8 min	ANO
A03	Šifonový dort	 150 °C	50 min	ANO
A04	Červený sametový cupcake	 160 °C	35 min	ANO
A05	Francouzská pečená vepřová kotleta	 200 °C	50 min	ANO
A06	Italský ovocný koláč (20 cm)	 190 °C	22 min	ANO

A07	Profiterolky	 190 °C	24 min	ANO
A08	Pečená treska	 250 °C	8 min	ANO
A09	Pečená kuřecí křídla	 L1 230 °C	25 min	ANO
A10	Pečená vepřová žebírka	 L1 200 °C	25 min	NE
A11	Pečená sajra	 L1 220 °C	14 min	ANO
A12	Celé pečené kuře	 L1 200 °C	45 min	ANO
A13	Vepřová pečeně	 L1 180 °C	50 min	ANO
A14	Francouzská jehněčí kotleta	 L1 220 °C	25 min	ANO
A15	Francouzské pečené vepřové koleno	 L1 230 °C	80 min	NE
A16	Tvarohový koláč	 L1 160 °C	55 min	ANO
A17	Čokoládový brusinkový chléb	 L1 180 °C	25 min	ANO
A18	Ořechový chléb	 L1 190 °C	30 min	ANO

Technické údaje

Technické údaje

Rozměry (vnitřní)	Šířka Výška Hloubka	503 mm 353 mm 386 mm
Plocha plechu na pečení	1 159 cm ²	
Horní topné těleso	900 W	
Spodní topné těleso	1 500 W	
Gril	1 300 W	
Prstenec	1 800 W	
Celkově	3 150 W	

Technické údaje

Napětí	220 – 240 V~
Frekvence	50 – 60 Hz
Počet funkcí	14

Technické údaje**Technické údaje**

Rozměry (vnitřní)	Šířka Výška Hloubka	503 mm 353 mm 386 mm
Plocha plechu na pečení	1 159 cm ²	
Horní topné těleso	900 W	
Spodní topné těleso	1 500 W	
Gril	1 300 W	
Prstenec	1 800 W	
Celkově	3 150 W	

Technické údaje

Napětí	220 – 240 V~
Frekvence	50 – 60 Hz
Počet funkcí	14

Energetická účinnost

Informace o výrobku a informační list výrobku*

Název dodavatele	IKEA
Identifikace modelu	MÅGEBÖ 905-570-61
Index energetické účinnosti	76,9
Třída energetické účinnosti	A+
Spotřeba energie při standardním zatížení, tradiční režim	1,02 kWh
Spotřeba energie při standardním zatížení, režim s ventilátorem	0,65 kWh
Počet vnitřních prostorů	1
Zdroj tepla	Elektřina
Objem	72 l
Typ trouby	Vestavná trouba
Hmotnost	43,5 kg
* Pro Evropskou unii podle nařízení EU 65/2014 a 66/2014. Pro Běloruskou republiku podle normy STB 2478-2017, dodatek G; normy STB 2477-2017, přílohy A a B.	
Třída energetické účinnosti se na Rusko nevztahuje.	
EN 60350-1 – Elektrické spotřebiče na vaření pro domácnost – Část 1: Sporáky, trouby, parní trouby a grily – Metody měření funkce.	

A készülék bemutatása

Általános áttekintés

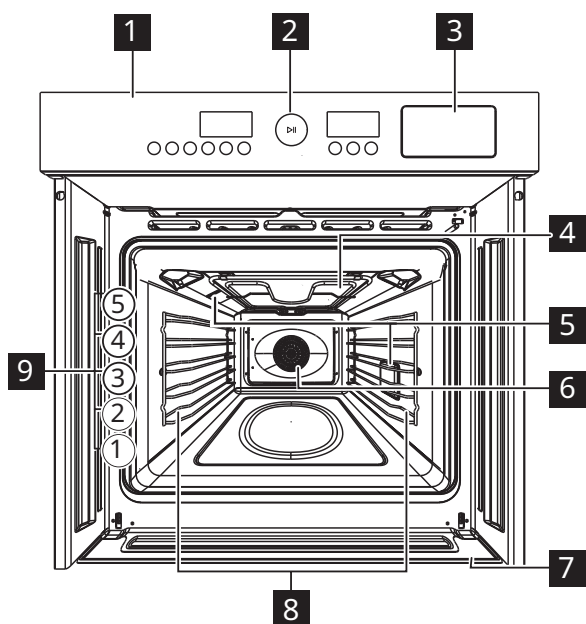

- 1 Kezelőpanel
- 2 Beállítógomb
- 3 Vízfiók
- 4 Grill
- 5 Lámpa
- 6 Ventilátor
- 7 Vízugyjtő
- 8 Polctartó, kivehető
- 9 Polcpozíciók

Kezelőpanel

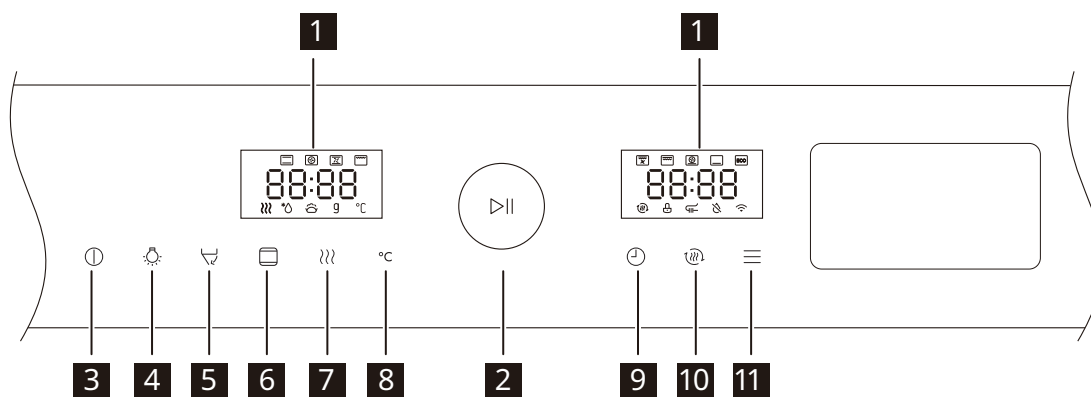

- 1 Kijelző
- 2 Forgógomb
- 3 Törlés
- 4 Lámpa
- 5 Víztartály
- 6 Módválasztó
- 7 Gőz
- 8 Hőmérséklet
- 9 Idő
- 10 Gyors előmelegítés
- 11 Auto menü

Kijelző

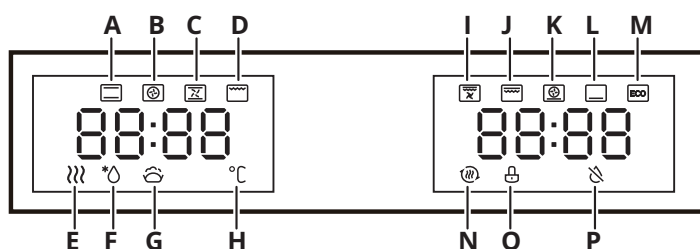

- | | |
|-----------------------------|---------------------------------|
| A. Hagyományos | I. Dupla grillezés + ventilátor |
| B. Hőáramlás | J. Dupla grillezés |
| C. Hagyományos + ventilátor | K. Pizza |
| D. Grill | L. Alsó fűtés |
| E. Gőz | M. ECO (takarékos) |
| F. Kiolvasztás | N. Gyors előmelegítés |
| G. Tésztakészítés | O. Gyermekszár |
| H. Hőmérséklet | P. Kevés a víz |

A menük áttekintése

- | | | |
|--|-------------------------------------|--|
| | Hagyományos | Nagy méretű torták. |
| | Hőáramlás | Különösen alkalmas olyan ételek sütéséhez, amelyeket egyenletesen kell pirítani. |
| | Hagyományos + ventilátor | A ventilátor és a fűtőelemek kombinációja még egyenletesebb hőmérsékletet biztosít, és akár 30-40% energiát takarít meg. |
| | Grill | Kis mennyiségű étel sütéséhez. |
| | Dupla grillezés + ventilátor | Lapos étel barbecue sütése. |
| | Dupla grillezés | Kis mennyiségű lapos étel sütéséhez. |
| | Pizza | Pizzasütés. |
| | Alsó fűtés | Lapos ételek aljának pirítása. |
| | ECO (takarékos) | Energiatakarékos sütéshez. |
| | Kiolvasztás | Fagyasztott élelmiszer kiolvasztása. |
| | Tésztakészítés | Tészta vagy joghurt erjesztése. |
| | Szárító funkció | Ezzel a funkcióval kiszárítható a sütőtér, és megelőzhető a baktériumok elszaporodása. |
| | Vízköltetés | A víztartályba citromsavat töltve eltávolítja a vízkövet a csőből. |

Sütés mód gőzrészegítés funkcióval

- | | | | | | |
|--|--------------------|--|-------------------|--|---------------------------------|
| | Hagyományos | | Grill | | Hagyományos + ventilátor |
| | Hőáramlás | | Alsó fűtés | | Gőztisztítás |

A víztartály használata

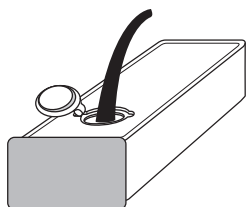

Amikor a víztartályt visszahelyez a foglalatába, ügyeljen rá, hogy teljesen betolja azt. A sütés után öntse ki a megmaradt vizet a víztartályból, majd törölje szárazra, hogy megakadályozza a baktériumok elszaporodását. A gőzrészegítés funkció és az automata menü használata előtt öntsön tisztított vizet a víztartályba.

1. mód

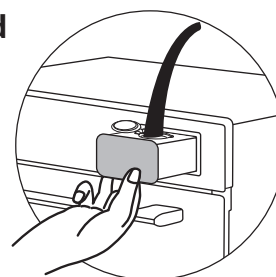

2. mód









1. A teljes víztartály kivételéhez nyomja meg a „” gombot, nyissa fel a gumigyűrűt, és öntsön vizet a tartályba.
2. Nyomja meg a „” gombot a víztartály kipattintásához, nyissa fel a gumigyűrűt, és öntsön vizet a tartályba.

Hibaelhárítás

Ha probléma van a készülékkel, olvassa el a „Mi a teendő, ha...” c. fejezetet a

teljes használati útmutatóban, amelyet a www.ikea.com webhelyen talál meg.

Automatikus menük táblázata

Kijelző	Menü	Mód vagy hőmérséklet	Idő	Előmelegítés
A01	Sült marhaborda	 250 °C	4 perc	IGEN
A02	Borsos marhasteak	 250 °C	8 perc	IGEN
A03	Piskóta	 150 °C	50 perc	IGEN
A04	Vörös bársony muffin	 160 °C	35 perc	IGEN
A05	Francia sült sertés kotlett	 200 °C	50 perc	IGEN
A06	Olasz gyümölcstorta (8 hüvelyk)	 190 °C	22 perc	IGEN
A07	Krém puff	 190 °C	24 perc	IGEN

A08	Sült tőkehal	 250 °C	8 perc	IGEN
A09	Sült csirkeszárny	 L1 230 °C	25 perc	IGEN
A10	Sült sertésborda	 L1 200 °C	25 perc	NEM
A11	Sült makrélacsuka	 L1 220 °C	14 perc	IGEN
A12	Egész sült csirke	 L1 200 °C	45 perc	IGEN
A13	Sült sertéshús	 L1 180 °C	50 perc	IGEN
A14	Francia bányaborda	 L1 220 °C	25 perc	IGEN
A15	Francia sült sertéskotlett	 L1 230 °C	80 perc	NEM
A16	Túrótorta	 L1 160 °C	55 perc	IGEN
A17	Csokoládés áfonyás kenyér	 L1 180 °C	25 perc	IGEN
A18	Diós kenyér	 L1 190 °C	30 perc	IGEN

Műszaki adatok

Műszaki adatok

Méreték (belső)	Szélesség Magasság Mélység	503 mm 353 mm 386 mm
Sütőtálca területe	1159 cm ²	
Felső fűtőelem	900 W	
Alsó fűtőelem	1500 W	
Grill	1300 W	
Gyűrű	1800 W	
Teljes névleges teljesítmény	3150 W	

Műszaki adatok

Feszültség	220–240 V~
Frekvencia	50–60 Hz
Funkciók száma	14

Műszaki adatok**Műszaki adatok**

Méreték (belső)	Szélesség Magasság Mélység	503 mm 353 mm 386 mm
Sütőtálca területe	1159 cm ²	
Felső fűtőelem	900 W	
Alsó fűtőelem	1500 W	
Grill	1300 W	
Gyűrű	1800 W	
Teljes névleges teljesítmény	3150 W	

Műszaki adatok

Feszültség	220–240 V~
Frekvencia	50–60 Hz
Funkciók száma	14

Energiahatékonyság

Termékadatok és termékinformációs táblázat*

Szállító neve	IKEA
Típusazonosítás	MÅGEBO 905-570-61
Energiahatékonysági index	76,9
Energiahatékonysági osztály	A+
Energiafogyasztás normál terhelés és hagyományos mód esetén	1,02 kWh
Energiafogyasztás normál terhelés és ventilátoros rásegítés esetén	0,65 kWh
Sütőterek száma	1
Fűtési mód	Elektromos
Térfogat	72 l
Sütő típusa	Beépített sütő
Tömeg	43,5 kg
* Az Európai Unió számára, a 65/2014 és a 66/2014 EU-rendelet szerint. Fehéroroszország számára az STB 2478-2017 G függeléke, valamint az STB 2477-2017 A és B függeléke szerint.	
Az energiahatékonysági osztály nem érvényes Oroszországban.	
EN 60350-1 – Háztartási elektromos főzőkészülékek – 1. rész: Tűzhelyek, sütők, gőzsütők és grillsütők – Vizsgálati módszerek a teljesítmény mérésére.	

Descrierea produsului

Prezentare generală

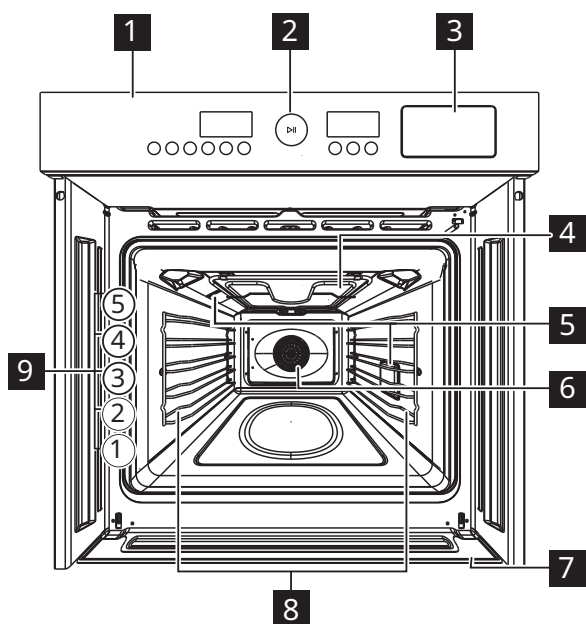

- 1 Panou de comandă
- 2 Buton pentru setare
- 3 Sertar de apă
- 4 Grătar
- 5 Bec
- 6 Ventilator
- 7 Colector de apă
- 8 Suport pentru rafturi, detașabil
- 9 Poziții de rafturi

Panou de comandă

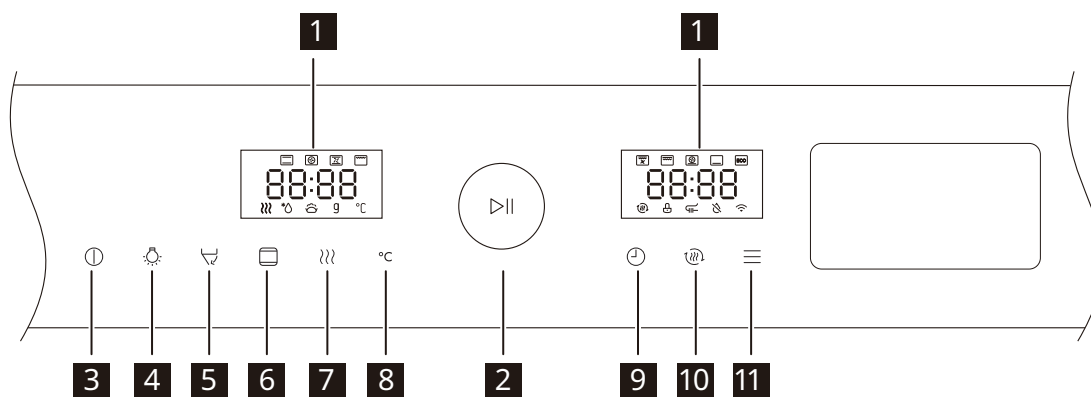

- 1 Afișaj
- 2 Buton
- 3 Anulare
- 4 Bec
- 5 Cutie de apă
- 6 Selectarea modului
- 7 Aburi
- 8 Temperatura
- 9 Durata
- 10 Preîncălzire rapidă
- 11 Meniu automat

Afișaj

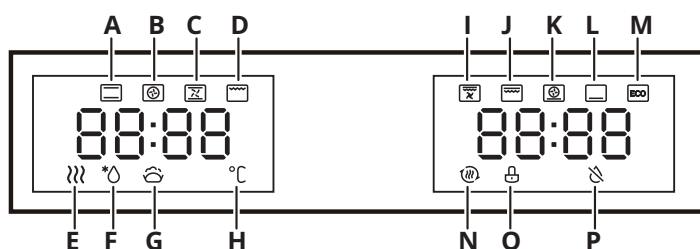

- | | |
|------------------------------|----------------------------|
| A. Convențional | J. Grătar dublu |
| B. Convecție | K. Pizza |
| C. Convențional + ventilator | L. Încălzire inferioară |
| D. Grătar | M. ECO |
| E. Aburi | N. Preîncălzire rapidă |
| F. Decongelare | O. Protecție pentru copii |
| G. Fermentare aluat | P. Absența apei ventilator |
| H. Temperatura | |
| I. Grătar dublu + ventilator | |

Prezentare generală a meniurilor

- | | | |
|--|----------------------------------|--|
| | Convențional | Prăjituri mari la cuptor. |
| | Convecție | Potrivit în special pentru coacerea alimentelor care trebuie să fie colorate uniform. |
| | Convențional + ventilator | Combinăția dintre ventilatoare și elementele de încălzire asigură o penetrare mai uniformă a căldurii, economisind până la 30-40% din energie. |
| | Grătar | Coaceți cantități mici de alimente. |
| | Grătar dublu + ventilator | Alimente plate la grătar. |
| | Grătar dublu | Coaceți cantități mici de alimente plate. |
| | Pizza | Pizza la cuptor. |
| | Încălzire inferioară | Colorați partea inferioară a alimentelor plate. |
| | ECO | Pentru gătit cu economie de energie. |
| | Decongelare | Dezghețați alimentele congelate. |
| | Fermentare aluat | Aluat sau iaurt fermentat. |
| | Funcția de uscare | Aceasta este utilizată pentru a usca interiorul cuptorului și pentru a împiedica dezvoltarea bacteriilor. |
| | Detartrare | Prin adăugarea de acid citric în cutia de apă, pentru a elimina calcarul din țeavă. |

Mod de gătit cu funcție de asistență cu abur

- | | | | | | |
|--|---------------------|--|-----------------------------|--|--------------------------------|
| | Convențional | | Grătar | | Convențional+ventilator |
| | Convecție | | Încălzire inferioară | | Curățarea cu abur |

Utilizarea cutiei de apă

Când puneți cutia de apă înapoi în locașul rezervorului, asigurați-vă că rezervorul de apă este împins până la capăt.

După gătit, aruncați apa rămasă în cutia de apă și ștergeți-o pentru a preveni dezvoltarea bacteriilor.

Atunci când utilizați funcția de asistență cu abur și meniul automat, adăugați în prealabil apă purificată în rezervorul de apă.

modul 1

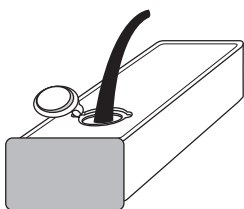

modul 2

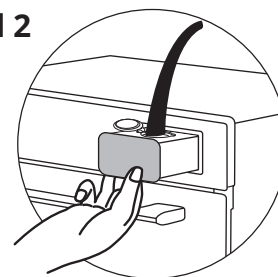







1. Faceți clic pe tasta „☑” pentru a scoate întreaga cutie de apă, deschideți inelul de cauciuc și adăugați apă.
2. Faceți clic pe tasta „☑” pentru a scoate cutia de apă, deschideți inelul de cauciuc și adăugați apă.













Depanare

Dacă întâmpinați o problemă cu aparatul dvs., verificați capitolul „Ce să faceți...”

din versiunea completă a Manualului de utilizare disponibil pe: www.ikea.com.

Pagina de meniu automat

Afișaj	Meniu	Mod sau temperatură	Durata	Preîncălzire
A01	Coaste de vită prăjite	 250 °C	4 min	DA
A02	Friptură de vită cu piper negru	 250 °C	8 min	DA
A03	Pandișpan american	 150 °C	50 min	DA
A04	Brioșă Red velvet	 160 °C	35 min	DA
A05	Friptură de cotlet de porc în stil francezesc	 200 °C	50 min	DA
A06	Plăcintă italiană cu fructe (20 cm)	 190 °C	22 min	DA

A07	Profiterol	 190 °C	24 min	DA
A08	Cod la cuptor	 250 °C	8 min	DA
A09	Aripioare de pui la cuptor	 L1 230 °C	25 min	DA
A10	Coaste de porc la cuptor	 L1 200 °C	25 min	NU
A11	Scrumbie la cuptor	 L1 220 °C	14 min	DA
A12	Pui întreg la cuptor	 L1 200 °C	45 min	DA
A13	Friptură de porc la cuptor	 L1 180 °C	50 min	DA
A14	Cotlet de miel în stil francezesc	 L1 220 °C	25 min	DA
A15	Friptură de porc la cuptor francezesc	 L1 230 °C	80 min	NU
A16	Cheese cake	 L1 160 °C	55 min	DA
A17	Chec de ciocolată cu afine	 L1 180 °C	25 min	DA
A18	Chec cu nucă	 L1 190 °C	30 min	DA

Date tehnice

Date tehnice

Dimensiuni (interne)	Lățime Înălțime Adâncime	503 mm 353 mm 386 mm
Suprafața tăvii de coacere	1159 cm ²	
Element de încălzire superior	900 W	
Element de încălzire inferior	1500 W	
Grătar	1300 W	
Inel	1800 W	
Putere totală	3150 W	

Date tehnice

Tensiune	220 - 240 V~
Frecvență	50 - 60 Hz
Numărul de funcții	14

Pentru a descărca versiunea completă, vizitați www.ikea.com

Date tehnice**Date tehnice**

Dimensiuni (interne)	Lățime Înălțime Adâncime	503 mm 353 mm 386 mm
Suprafața tăvii de coacere	1159 cm ²	
Element de încălzire superior	900 W	
Element de încălzire inferior	1500 W	
Grătar	1300 W	
Inel	1800 W	
Putere totală	3150 W	

Date tehnice

Tensiune	220 - 240 V~
Frecvență	50 - 60 Hz
Numărul de funcții	14

Eficiența energetică

Informații despre produs și fișa de informații despre produs*

Numele furnizorului	IKEA
Identificarea modelului	MÅGEBO 905-570-61
Indicele de eficiență energetică	76,9
Clasa de eficiență energetică	A+
Consumul de energie cu o sarcină standard, în modul convențional	1,02 kWh
Consumul de energie cu o sarcină standard, în modul cu ventilator	0,65 kWh
Numărul de cavități	1
Sursă de căldură	Electricitate
Volum	72 l
Tipul de cuptor	Cuptor încorporat
Masa	43,5 kg
* Pentru Uniunea Europeană, în conformitate cu Regulamentele UE 65/2014 și 66/2014. Pentru Republica Belarus, în conformitate cu STB 2478-2017, anexa G; STB 2477-2017, anexele A și B.	
Clasa de eficiență energetică nu se aplică pentru Rusia.	
EN 60350-1 - Aparate electrice de gătit pentru uz casnic. Partea 1: Clase, cuptoare, cuptoare cu aburi și grătare - Metode de măsurare a performanțelor.	

Popis výrobku

Všeobecný prehľad

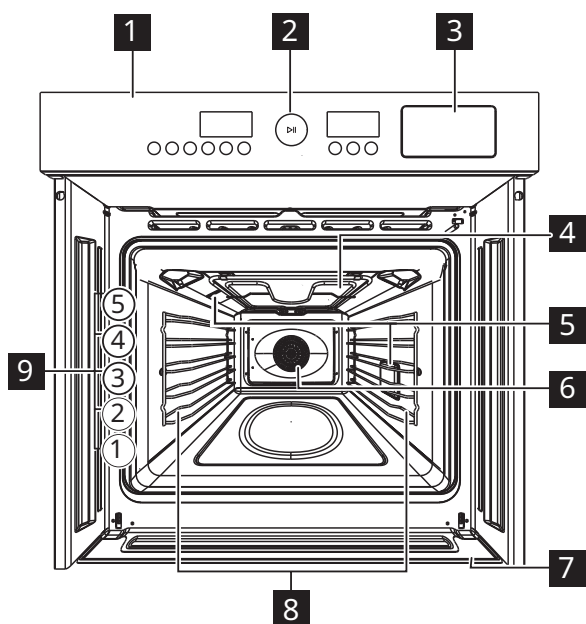

- 1 Ovládací panel
- 2 Knoflík na nastavenie
- 3 Zásuvka na vodu
- 4 Gril
- 5 Svetlo
- 6 Ventilátor
- 7 Zberač vody
- 8 Opora police, odnímateľná
- 9 Pozície police

Ovládací panel

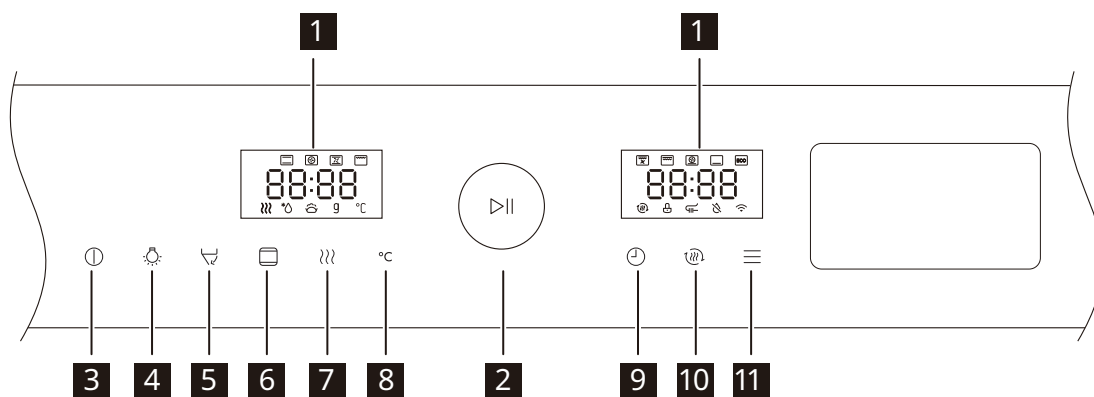

- 1 Displej
- 2 Otočný regulátor
- 3 Zrušiť
- 4 Svetlo
- 5 Nádobka na vodu
- 6 Výber režimu
- 7 Para
- 8 Teplota
- 9 Čas
- 10 Rýchly predohrev
- 11 Automatická ponuka

Displej

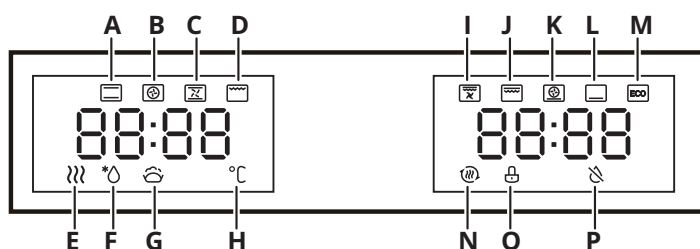

- | | |
|------------------------------|----------------------|
| A. Konvekčné | J. Dvojitý gril |
| B. Konvekcia | K. Pizza |
| C. Konvekčné + ventilátor | L. Spodný ohrev |
| D. Gril | M. ECO |
| E. Para | N. Rýchly predohrev |
| F. Rozmrazovanie | O. Bezpečné pre deti |
| G. Kysnutie cesta | P. Nedostatok vody |
| H. Teplota | |
| I. Dvojitý gril + ventilátor | |

Prehľad ponúk

	Konvekčné	Upečené veľké koláče.
	Konvekcia	Vhodné najmä na pečenie potravín, ktoré je potrebné rovnomerne zafarbiť.
	Konvekčné + ventilátor	Kombinácia ventilátorov a vykurovacích telies zaisťuje rovnomernejšie prenikanie tepla, čím sa ušetrí až 30 - 40 % energie.
	Gril	Pečenie malého množstva jedla.
	Dvojitý gril + ventilátor	Ploché grilované jedlo.
	Dvojitý gril	Pečenie malého množstva plochého jedla.
	Pizza	Pečená pizza.
	Spodný ohrev	Farba spodku plochého jedla.
	ECO	Na úsporné varenie.
	Rozmrazovanie	Rozmrazovanie mrazených potravín.
	Kysnutie cesta	Kysnuté cesto alebo jogurt.
	Funkcia sušenia	Používa sa na sušenie komory rúry a zabránenie rastu baktérií.
	Odvápňovanie	Pridaním kyseliny citrónovej do nádoby na vodu odstránite vodný kameň.

Režim varenia s funkciou parného asistenta

	Konvekčné		Gril		Konvekčné + ventilátor
	Konvekcia		Spodný ohrev		Čistenie parou

Používanie nádoby na vodu

Pri vkladaní nádoby na vodu späť do sedla nádrže sa uistite, že je nádržka na vodu úplne zatlačená.

Po uvarení zlikvidujte všetku zvyšnú vodu v nádobe na vodu a utrite dosucha, aby ste zabránili množeniu baktérií.

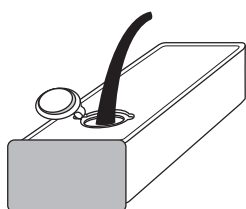

Pri používaní funkcie parného asistenta a automatickej ponuky pridajte do nádržky na vodu vopred čistú vodu.

1. spôsob

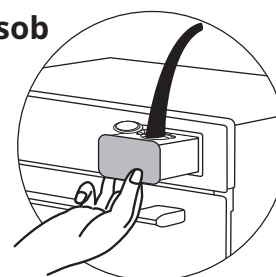

2. spôsob









1. Kliknutím na tlačidlo „“ vyťahnite celú nádobu na vodu, otvorte gumený krúžok a pridajte vodu.
2. Kliknutím na tlačidlo „“ vysuňte nádobu na vodu, otvorte gumený krúžok a pridajte vodu.

Riešenie problémov

Ak narazíte na problém so svojím spotrebičom, pozrite si kapitolu „Čo robiť,

ak...“ v plnej verzii používateľskej príručky dostupnej na: www.ikea.com.

Hárok automatickej ponuky

Displej	Ponuka	Režim alebo teplota	Čas	Predohrev
A01	Pečené hovädzie rebrá	 250 °C	4 min	ÁNO
A02	Hovädzí steak s čiernym korením	 250 °C	8 min	ÁNO
A03	Piškótová torta	 150 °C	50 min	ÁNO
A04	Košíček z červeného zamatu	 160 °C	35 min	ÁNO
A05	Francúzska pečená bravčová kotleta	 200 °C	50 min	ÁNO
A06	Taliansky ovocný koláč (8 palcov)	 190 °C	22 min	ÁNO

A07	Krémová bábovka	 190 °C	24 min	ÁNO
A08	Pečená treska	 250 °C	8 min	ÁNO
A09	Pečené kuracie krídelká	 L1 230 °C	25 min	ÁNO
A10	Pečené bravčové rebrá	 L1 200 °C	25 min	NO
A11	Pečená klobása	 L1 220 °C	14 min	ÁNO
A12	Pečené celé kura	 L1 200 °C	45 min	ÁNO
A13	Pečené bravčové	 L1 180 °C	50 min	ÁNO
A14	Francúzske pečené bravčové koleno	 L1 220 °C	25 min	ÁNO
A15	Francúzske pečené bravčové koleno	 L1 230 °C	80 min	NO
A16	Tvarohový koláč	 L1 160 °C	55 min	ÁNO
A17	Čokoládový brusnicový chlieb	 L1 180 °C	25 min	ÁNO
A18	Orechový chlieb	 L1 190 °C	30 min	ÁNO

Technické údaje

Technické údaje

Rozmery (vnútorné)	Šírka Výška Hĺbka	503 mm 353 mm 386 mm
Oblasť plechu na pečenie	1159 cm ²	
Vrchný výhrevný prvok	900 W	
Spodný výhrevný prvok	1500 W	
Gril	1300 W	
Kruh	1800 W	
Celkový príkon	3150 W	

Technické údaje

Napätie	220 – 240 V~
Frekvencia	50 – 60 Hz
Počet funkcií	14

Kompletnú verziu si môžete prevziať na www.ikea.com

Technické údaje**Technické údaje**

Rozmery (vnútorné)	Šírka Výška Hĺbka	503 mm 353 mm 386 mm
Oblasť plechu na pečenie	1159 cm ²	
Vrchný výhrevný prvok	900 W	
Spodný výhrevný prvok	1500 W	
Gril	1300 W	
Kruh	1800 W	
Celkový príkon	3150 W	

Technické údaje

Napätie	220 – 240 V~
Frekvencia	50 – 60 Hz
Počet funkcií	14

Energetická účinnosť

Informácie o výrobku a hárok s informáciami o výrobku*

Názov dodávateľa	IKEA
Identifikácia modelu	MÅGEBO 905-570-61
Index energetickej účinnosti	76,9
Trieda energetickej účinnosti	A+
Spotreba energie pri bežnej záťaži, konvekčný režim	1,02 kWh
Spotreba energie pri bežnej záťaži, režim s ventilátorom	0,65 kWh
Počet komôr	1
Zdroj tepla	Elektrina
Objem	72 l
Typ rúry	Vstavaná rúra
Hmotnosť	43,5 kg
* Pre Európsku úniu v súlade so Smernicami EÚ 65/2014 a 66/2014. Pre Bielorusko v súlade so smernicou STB 2478-2017, dodatok G; STB 2477-2017, dodatky A a B.	
Trieda energetickej účinnosti sa nevzťahuje na Rusko.	
EN 60350-1 – Domáce elektrické spotrebiče na varenie – Časť 1: Sporáky, rúry, parné rúry a grily – Metódy merania výkonu.	

Opis proizvoda

Opšti pregled

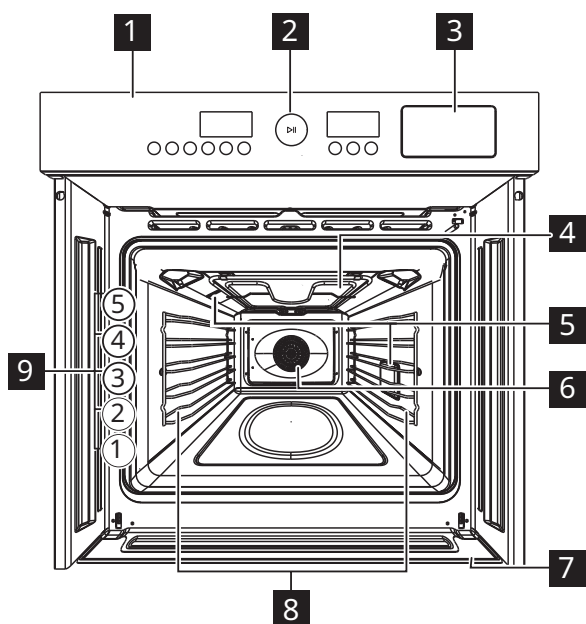

- 1 Komandna tabla
- 2 Dugme za postavke
- 3 Fioka za vodu
- 4 Roštilj
- 5 Lampa
- 6 Ventilator
- 7 Kolektor za vodu
- 8 Nosači polica, uklonjivi
- 9 Pozicije polica

Komandna tabla

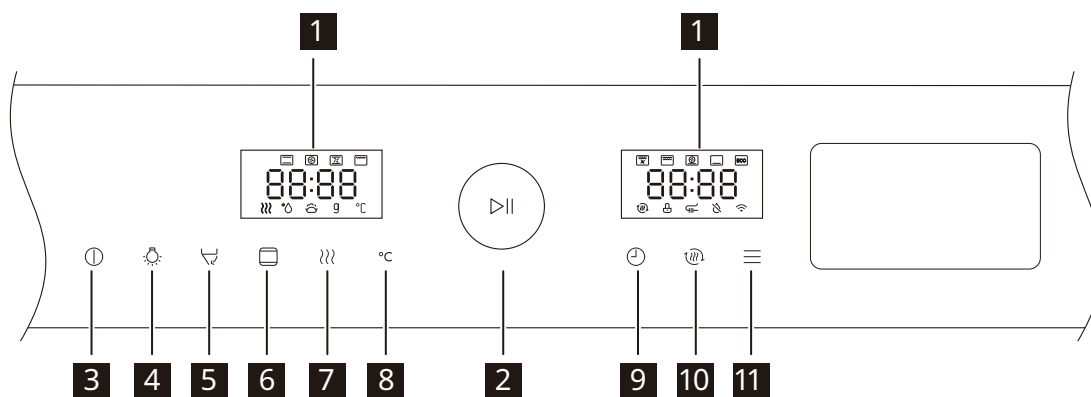

- 1 Ekran
- 2 Dugme
- 3 Otkazi
- 4 Lampa
- 5 Kutija za vodu
- 6 Izbor režima
- 7 Para
- 8 Temperatura
- 9 Vreme
- 10 Brzo predzagrevanje
- 11 Automatski meni

Ekran

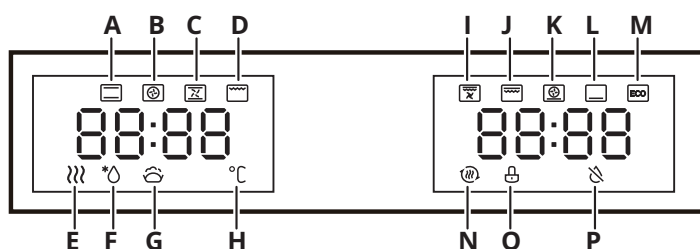

- | | |
|-----------------------------------|------------------------|
| A. Konvencionalno | J. Dvostruki roštilj |
| B. Konvekcija | K. Pica |
| C. Konvencionalno + ventilator | L. Donje grejanje |
| D. Roštilj | M. EKO |
| E. Para | N. Brzo predzagrevanje |
| F. Odmrzavanje | O. Brava za decu |
| G. Dizanje testa | P. Nedovoljno vode |
| H. Temperatura | |
| I. Dvostruki roštilj + ventilator | |

Pregled menija

	Konvencionalno	Pečeni veliki kolači.
	Konvekcija	Posebno je pogodan za pečenje hrane koja treba da bude ravnomerne boje.
	Konvencionalno + ventilator	Kombinacija ventilatora i grejnih elemenata obezbeđuje ravnomernije prodiranje toplote, štedeći do 30 - 40% energije.
	Rešetka	Pecite male količine hrane.
	Dvostruki roštilj + ventilator	Roštiljajte tanko isečenu hranu.
	Dvostruki roštilj	Pecite male količine tanko isečene hrane.
	Pica	Pečena pica.
	Donje grejanje	Dodajte boju na dno tanko isečene hrane.
	EKO	Za kuvanje sa uštedom energije.
	Odmrzavanje	Odmrznete smrznutu hranu.
	Dizanje testa	Fermentisano testo ili jogurt.
	Funkcija sušenja	Koristi se za sušenje komore pećnice i sprečavanje razvoja bakterija.
	Uklanjanje kamenca	Dodavanjem limunske kiseline u kutiju za vodu, radi uklanjanja kamenca u cevi.

Režim kuvanja sa funkcijom parne podrške

	Konvencionalno		Rešetka		Konvencionalno + ventilator
	Konvekcija		Donje grejanje		Čišćenje parom

Korišćenje kutije za vodu

Kada vratite kutiju za vodu u ležište rezervoara, uverite se da je rezervoar za vodu gurnut do kraja.

Nakon kuvanja, prospite preostalu vodu iz kutije za vodu i obrišite je da biste sprečili razvoj bakterija.

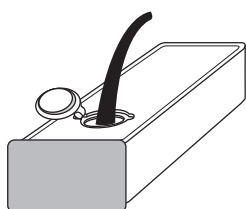

Kada koristite funkciju parne podrške i automatski meni, unapred dodajte prečišćenu vodu u rezervoar za vodu.

1. način

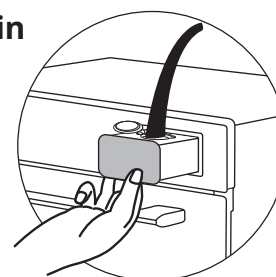

2. način









1. Kliknite na taster „“ da biste izvadili celu kutiju za vodu, otvorite gumeni prsten i dodajte vodu.
2. Kliknite na taster „“ da bi iskočila kutija za vodu, otvorite gumeni prsten i dodajte vodu.

Rešavanje problema

Ako naiđete na problem sa svojim uređajem, kompletnoj verziji korisničkog priručnika pogledajte poglavlje „Šta uraditi ako...“ u dostupnoj na: www.ikea.com.

List sa automatskim menijem

Ekran	Meni	Režim ili temperatura	Vreme	Predzagrevanje
A01	Pečena goveđa rebra	 250 °C	4 min.	DA
A02	Goveđi odrezak sa crnim biberom	 250 °C	8 min.	DA
A03	Šifon kolač	 150 °C	50 min.	DA
A04	Kolač crveni somot	 160 °C	35 min.	DA
A05	Pečeni francuski svinjski kotlet	 200 °C	50 min.	DA
A06	Italijanska voćna pita (8 inča)	 190 °C	22 min.	DA

A07	Puf krem	 190 °C	24 min.	DA
A08	Pečeni bakalar	 250 °C	8 min.	DA
A09	Pečena pileća krilca	 L1 230 °C	25 min.	DA
A10	Pečena svinjska rebra	 L1 200 °C	25 min.	NE
A11	Pečeni sauri	 L1 220 °C	14 min.	DA
A12	Pečeno celo pile	 L1 200 °C	45 min.	DA
A13	Praseće pečenje	 L1 180 °C	50 min.	DA
A14	Francuski jagnjeći kotlet	 L1 220 °C	25 min.	DA
A15	Pečeni francuski svinjski kotlet	 L1 230 °C	80 min.	NE
A16	Čizkejk	 L1 160 °C	55 min.	DA
A17	Čokoladni hleb sa brusnicom	 L1 180 °C	25 min.	DA
A18	Hleb sa orašastim plodovima	 L1 190 °C	30 min.	DA

Tehnički podaci

Tehnički podaci

Dimenzije (unutrašnje)	Širina Visina Dubina	503 mm 353 mm 386 mm
Područje pleha za pečenje	1159 cm ²	
Gornji grejni element	900 W	
Donji grejni element	1500 W	
Roštilj	1300 W	
Prsten	1800 W	
Ukupna snaga	3150 W	

Tehnički podaci

Napon	220 – 240 V~
Frekvencija	50 – 60 Hz
Broj funkcija	14

Da biste preuzeli kompletnu verziju, posetite www.ikea.com

Tehnički podaci

Tehnički podaci

Dimenzije (unutrašnje)	Širina Visina Dubina	503 mm 353 mm 386 mm
Područje pleha za pečenje	1159 cm ²	
Gornji grejni element	900 W	
Donji grejni element	1500 W	
Roštilj	1300 W	
Prsten	1800 W	
Ukupna snaga	3150 W	

Tehnički podaci

Napon	220 – 240 V~
Frekvencija	50 – 60 Hz
Broj funkcija	14

Energetska efikasnost

Informacije o proizvodu i list sa informacijama o proizvodu*

Naziv dobavljača	IKEA
Identifikacije uređaja	MÅGEBO 905-570-61
Indeks energetske efikasnosti	76,9
Klasa energetske efikasnosti	A+
Potrošnja energije sa standardnim opterećenjem, konvencionalni režim	1,02 kWh
Potrošnja energije sa standardnim opterećenjem, režim sa ventilatorom	0,65 kWh
Broj komora	1
Izvor toplote	Električna energija
Zapremina	72 l
Vrsta pećnice	Ugradna pećnica
Masa	43,5 kg
* Za Evropsku uniju u skladu sa propisima EU 65/2014 i 66/2014. Za Republiku Belorusiju u skladu sa STB 2478-2017, dodatak G; STB 2477-2017, prilozi A i B.	
Klasa energetske efikasnosti nije primenljiva za Rusiju.	
EN 60350-1 - Kućni električni aparati za kuvanje - Deo 1: Peći, peći, parne peći i roštilji - Metode za merenje performansi.	

Opis proizvoda

Opći pregled

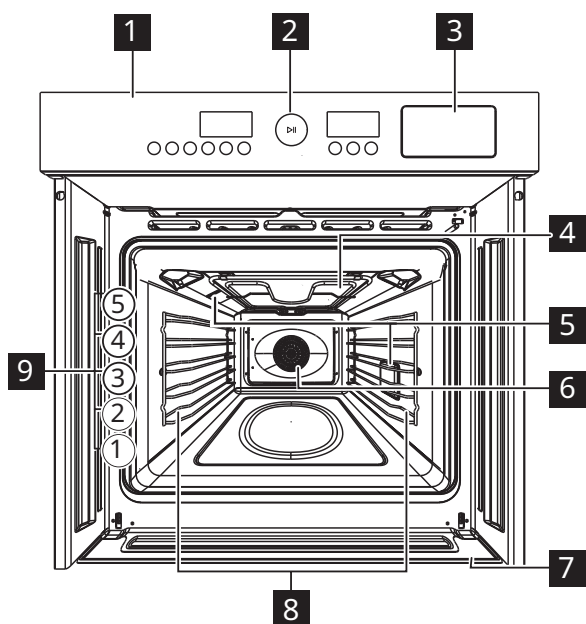

- 1 Upravljačka ploča
- 2 Gumb za postavljanje
- 3 Ladica za vodu
- 4 Rešetka
- 5 Lampica
- 6 Ventilator
- 7 Sakupljač vode
- 8 Nosač police, uklonjiv
- 9 Položaji polica

Upravljačka ploča

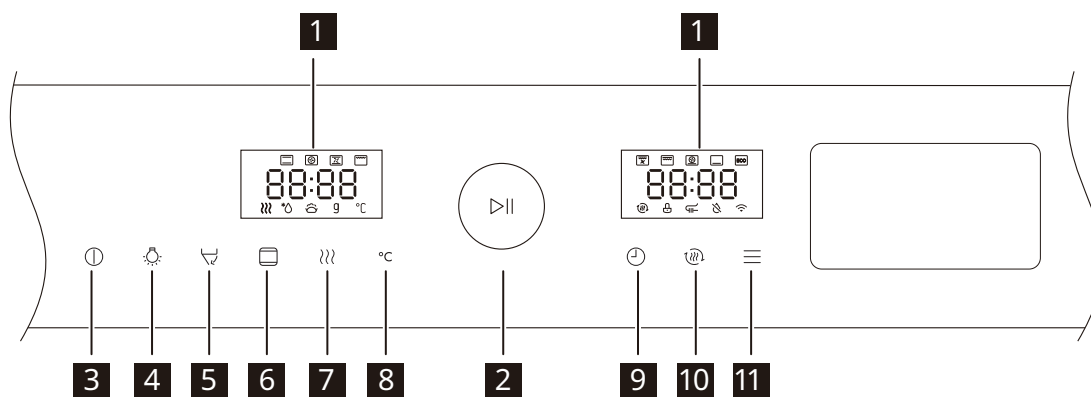

- 1 Zaslón
- 2 Gumb
- 3 Poništavanje
- 4 Lampica
- 5 Kutija za vodu
- 6 Odabir načina rada
- 7 Para
- 8 Temperatura
- 9 Vrijeme
- 10 Izuzetno brzo predgrijavanje
- 11 Automatski izbornik

Zaslon

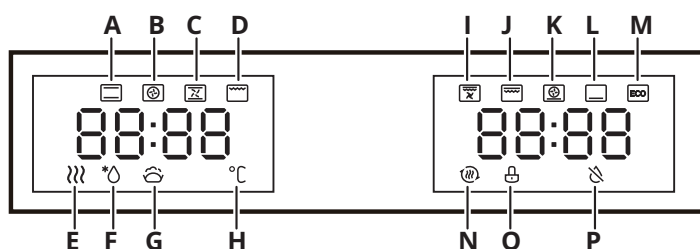

- | | |
|--------------------------------|-----------------------------------|
| A. Konvencionalno | I. Dvostruki roštilj + ventilator |
| B. Konvekcija | J. Dvostruki roštilj |
| C. Konvencionalno + ventilator | K. Pizza |
| D. Rešetka | L. Donji grijač |
| E. Para | M. ECO |
| F. Odmrzavanje | N. Brzo predgrijavanje |
| G. Provjera tijesta | O. Sigurno za djecu |
| H. Temperatura | P. Manjak vode |

Pregled izbornika

- | | | |
|--|---------------------------------------|--|
| | Konvencionalno | Velike pečene torte. |
| | Konvekcija | Posebno pogodan za pečenje hrane koja mora biti ravnomjerno obojena. |
| | Konvencionalno + ventilator | Kombinacija ventilatora i grijaćih elemenata omogućuje ravnomjerniji prodor topline, čime se štedi do 30-40% energije. |
| | Roštilj | Pecite male količine hrane. |
| | Dvostruki roštilj + ventilator | Ravni roštilj. |
| | Dvostruki roštilj | Pecite male količine ravne hrane. |
| | Pizza | Pečena pizza. |
| | Donji grijač | Obojite dno plosnate hrane. |
| | ECO | Za kuhanje uz uštedu energije. |
| | Odmrzavanje | Odmrznite smrznutu hranu. |
| | Provjera tijesta | Dizano tijesto ili jogurt. |
| | Funkcija sušenja | Koristi se za sušenje komore peći i sprječava rast bakterija. |
| | Uklanjanje kamenca | Dodavanjem limunske kiseline u kutiju za vodu, za uklanjanje kamenca u cijevi. |

Način kuhanja s funkcijom pomoći pare

- | | | | | | |
|--|----------------|--|--------------|--|-----------------------------|
| | Konvencionalno | | Roštilj | | Konvencionalno + ventilator |
| | Konvekcija | | Donji grijač | | Čišćenje parom |

Korištena kutija za vodu

Kada vraćate kutiju za vodu natrag u sjedište spremnika, provjerite je li spremnik za vodu gurnut do kraja.

Nakon kuhanja, bacite svu preostalu vodu u kutiju za vodu i obrišite kako biste spriječili razvoj bakterija.

Kada koristite funkciju za pomoć pari i automatski izbornik, unaprijed dodajte pročišćenu vodu u spremnik za vodu.

način 1

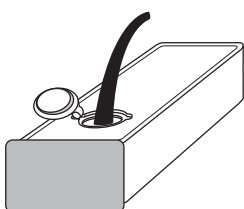

način 2

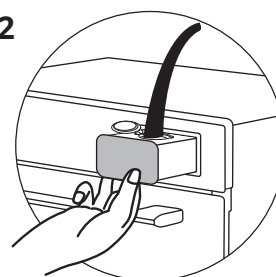

1. Kliknite tipku "☑" za vađenje cijele kutije za vodu, otvorite gumeni prsten i dodajte vodu.
2. Kliknite ključ "☑" za vađenje kutije za vodu, otvorite gumeni prsten i dodajte vodu.

Otklanjanje poteškoća

Ako naiđete na problem sa svojim uređajem, verziji korisničkog priručnika dostupnog na: provjerite poglavlje "Što učiniti..." u punoj www.ikea.com.

List automatskog izbornika

Zaslon	Izbornik	Način rada ili Temperatura	Vrijeme	Predgrijavanje
A01	Pečena goveđa rebra	250 °C	4 min	DA
A02	Goveđi odrezak s crnim paprom	250 °C	8 min	DA
A03	Chiffon torta	150°C	50 min	DA
A04	Kolač od crvenog baršuna	160 °C	35 min	DA
A05	Pečeni svinjski kotlet	200 °C	50 min	DA
A06	Talijanska voćna pita (8 inča)	190 °C	22 min	DA
A07	Puslice	190 °C	24 min	DA

A08	Pečeni bakalar	 250 °C	8 min	DA
A09	Pečena pileća krilca	 L1 230 °C	25 min	DA
A10	Pečena svinjska rebra	 L1 200 °C	25 min	NE
A11	Pečena skuša	 L1 220 °C	14 min	DA
A12	Pečeno cijelo pile	 L1 200 °C	45 min	DA
A13	Pečena svinjetina	 L1 180 °C	50 min	DA
A14	Francuski janjeći kotlet	 L1 220 °C	25 min	DA
A15	Francuska pečena svinjska koljenica	 L1 230 °C	80 min	NE
A16	Torta od sira	 L1 160 °C	55 min	DA
A17	Čokoladni kruh s brusnicama	 L1 180 °C	25 min	DA
A18	Kruh s orašastim plodovima	 L1 190 °C	30 min	DA

Tehnički podaci

Tehnički podaci

Dimenzije (unutarnje)	Širina Visina Dubina	503 mm 353 mm 386 mm
Površina pleha za pečenje	1159 cm ²	
Gornji grijač	900 W	
Donji grijaći element	1500 W	
Rešetka	1300 W	
Prsten	1800 W	
Ukupna snaga	3150 W	

Tehnički podaci

Napon	220 – 240V~
Frekvencija	50 – 60 Hz
Broj funkcija	14

Tehnički podaci**Tehnički podaci**

Dimenzije (unutarnje)	Širina	503 mm
	Visina	353 mm
	Dubina	386 mm
Površina pleha za pečenje	1159 cm ²	
Gornji grijač	900 W	
Donji grijaći element	1500 W	
Rešetka	1300 W	
Prsten	1800 W	
Ukupna snaga	3150 W	

Tehnički podaci

Napon	220 – 240V~
Frekvencija	50 – 60 Hz
Broj funkcija	14

Energetska učinkovitost

Podaci o proizvodu i list s podacima o proizvodu*

Naziv dobavljača	IKEA
Naziv modela	MÅGEBO 905-570-61
Indeks energetske učinkovitosti	76,9
Razred energetske učinkovitosti	A+
Potrošnja energije sa standardnim opterećenjem, konvencionalni način rada	1,02kWh
Potrošnja energije sa standardnim opterećenjem, prisilni način rada ventilatora	0,65kWh
Broj šupljina	1
Izvor topline	Struja
Volumen	72 l
Vrsta pećnice	Ugradbena pećnica
Težina	43,5 kg
* Za Europsku uniju prema Uredbama EU 65/2014 i 66/2014. Za Republiku Bjelorusiju prema STB 2478-2017, Dodatak G; STB 2477-2017, Dodaci A i B.	
Klasa energetske učinkovitosti nije primjenjiva za Rusiju.	
EN 60350-1 - Kućanski električni aparati za kuhanje - 1. dio: Štednjaci, pećnice, parne pećnice i roštilji – metode za mjerenje učinka.	

Opis izdelka

Splošni pregled

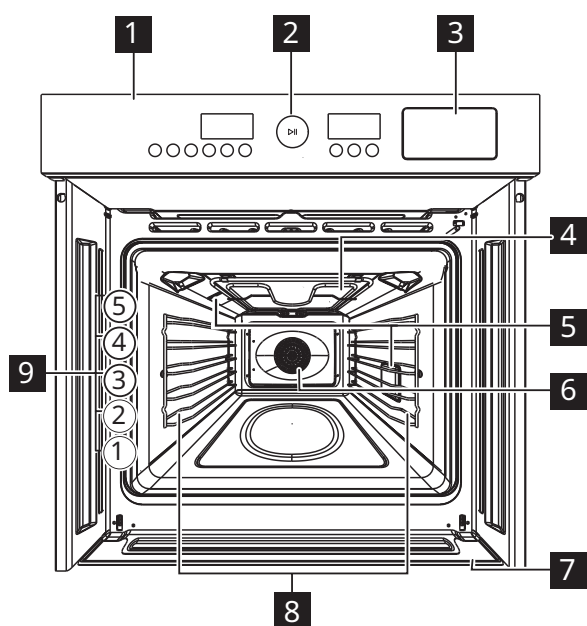

- 1 Nadzorna plošča
- 2 Nastavitveni gumb za nastavitev
- 3 Predal za vodo
- 4 Žar
- 5 Lučka
- 6 Ventilator
- 7 Zbiralnik vode
- 8 Nosilci za police, odstranljivi
- 9 Položaji za namestitev police

Nadzorna plošča

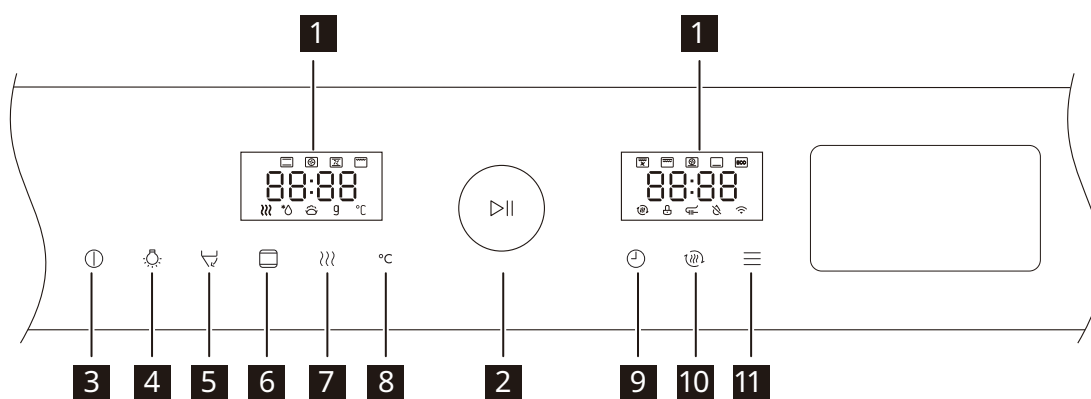

- 1 Prikaz
- 2 Gumb
- 3 Preklic
- 4 Lučka
- 5 Posoda za vodo
- 6 Izbira načina
- 7 Para
- 8 Temperatura
- 9 Čas
- 10 Hitro predgrevanje
- 11 Samodejni meni

Prikaz

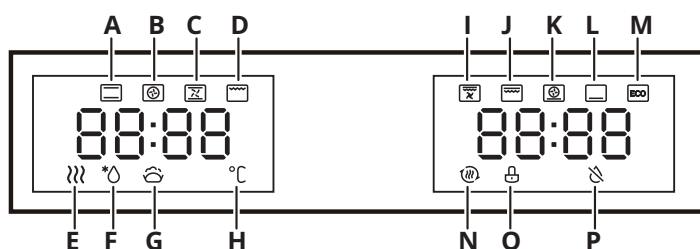

- | | |
|--------------------------------|----------------------------|
| A. Konvencionalno | I. Dvojni žar + ventilator |
| B. Konvekcija | J. Dvojni žar |
| C. Konvencionalno + ventilator | K. Pica |
| D. Žar | L. Gretje spodaj |
| E. Para | M. EKO |
| F. Odmrzovanje | N. Hitro predgretje |
| G. Vzhajanje testa | O. Otroška ključavnica |
| H. Temperatura | P. Premalo vode |

Pregled menijev

	Konvencionalno	Velike pečene torte.
	Konvekcija	Še posebej primeren je za peko hrane, ki mora biti enakomerno obarvana.
	Konvencionalno + ventilator	Kombinacija ventilatorjev in grelnih elementov zagotavlja enakomernejši prodor toplote, kar prihrani od 30 % do 40 % energije.
	Žar	Pecite majhne količine hrane.
	Dvojni žar + ventilator	Zapecite ploska živila.
	Dvojni žar	Specite manjše količine ploskih živil.
	Pica	Pečena pica.
	Gretje spodaj	Zapecite spodnjo stran ploskih živil.
	EKO	Za energetske varčno kuhanje.
	Odmrzovanje	Odmrznite zamrznjeno hrano.
	Vzhajanje testa	Fermentirano testo ali jogurt.
	Funkcija sušenja	Uporablja se za sušenje komore peči in preprečevanje rasti bakterij.
	Odstranjevanje vodnega kamna	Z dodajanjem citronske kisline v posodo za vodo, da odstranite vodni kamen v cevi.

Način kuhanja s funkcijo pomoči s paro

	Konvencionalno		Žar		Konvencionalno + ventilator
	Konvekcija		Gretje spodaj		Parno čiščenje

Uporaba posode za vodo

Ko posodo za vodo postavljate nazaj v odprtino za posodo, se prepričajte, da je posoda za vodo potisnjena do konca.

Po kuhanju zavržite preostalo vodo v posodi za vodo in le-to obrišite do suhega, da preprečite rast bakterij.

Ko uporabljate funkcijo pomoči s paro in samodejni meni, v posodo za vodo vnaprej dodajte prečiščeno vodo.

način 1

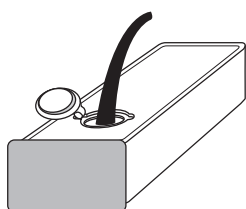

način 2

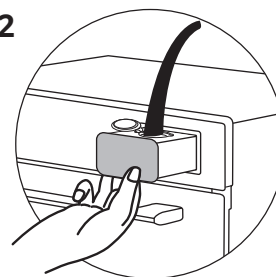







1. Pritisnite tipko »

Odpravljanje napak

Če naletite na težavo z napravo, preverite poglavje »Kaj storiti, če ...« v celotni

različici uporabniškega priročnika na: www.ikea.com.

List samodejnega menija

Prikaz	Meni	Način ali temperatura	Čas	Predgretje
A01	Pečena goveja rebra	 250 °C	4 min	DA
A02	Goveji zrezek s črnim poprom	 250 °C	8 min	DA
A03	Šifonska torta	 150 °C	50 min	DA
A04	Rdeča žametna tortica	 160 °C	35 min	DA
A05	Francoski pečen svinjski kotlet	 200 °C	50 min	DA
A06	Italijanska sadna pita (pribl. 20 cm)	 190 °C	22 min	DA

A07	Profiteroli	 190 °C	24 min	DA
A08	Pečena trska	 250 °C	8 min	DA
A09	Pečene piščančje perutničke	 L1 230 °C	25 min	DA
A10	Pečena svinjina rebra	 L1 200 °C	25 min	NE
A11	Pečena saury	 L1 220 °C	14 min	DA
A12	Pečen piščanec (cel)	 L1 200 °C	45 min	DA
A13	Pečeno svinjsko meso	 L1 180 °C	50 min	DA
A14	Francoski jagnječji kotlet	 L1 220 °C	25 min	DA
A15	Francoska pečena svinjska krača	 L1 230 °C	80 min	NE
A16	Sirova torta	 L1 160 °C	55 min	DA
A17	Čokoladno-brusnični kruh	 L1 180 °C	25 min	DA
A18	Kruh z oreščki	 L1 190 °C	30 min	DA

Tehnični podatki

Tehnični podatki

Dimenzije (notranje)	Širina Višina Globina	503 mm 353 mm 386 mm
Površina pekača	1159 cm ²	
Zgornji grelni element	900 W	
Spodnji grelni element	1500 W	
Žar	1300 W	
Obroč	1800 W	
Skupna nazivna moč	3150 W	

Tehnični podatki

Napetost	220–240 V
Frekvenca	50–60 Hz
Število funkcij	14

Če želite prenesti celotno različico, obiščite www.ikea.com

Tehnični podatki**Tehnični podatki**

Dimenzije (notranje)	Širina	503 mm
	Višina	353 mm
	Globina	386 mm
Površina pekača	1159 cm ²	
Zgornji grelni element	900 W	
Spodnji grelni element	1500 W	
Žar	1300 W	
Obroč	1800 W	
Skupna nazivna moč	3150 W	

Tehnični podatki

Napetost	220–240 V
Frekvenca	50–60 Hz
Število funkcij	14

Energetska učinkovitost

Informacije o izdelku in list s podatki o izdelku*

Ime dobavitelja	IKEA
Identifikacija modela	MÅGEBO 905-570-61
Indeks energetske učinkovitosti	76,9
Razred energetske učinkovitosti	A+
Poraba energije pri standardni obremenitvi, konvencionalni način	1,02 kWh
Poraba energije pri standardni obremenitvi, ventilatorski način	0,65 kWh
Število prostorov za peko	1
Vir toplote	Elektrika
Prostornina	72 l
Vrsta pečice	Vgradna pečica
Teža	43,5 kg
* Za Evropsko unijo v skladu z uredbama EU 65/2014 in 66/2014. Za Belorusijo v skladu s STB 2478-2017, Dodatek G; STB 2477-2017, Priloga A in B.	
Razred energetske učinkovitosti ne velja za Rusijo.	
EN 60350-1 – Gospodinjski električni kuhalni aparati – 1. del: Štedilniki, pečice, parne pečice in žari – Metode za merjenje funkcionalnosti.	

Описание на продукта

Общ преглед

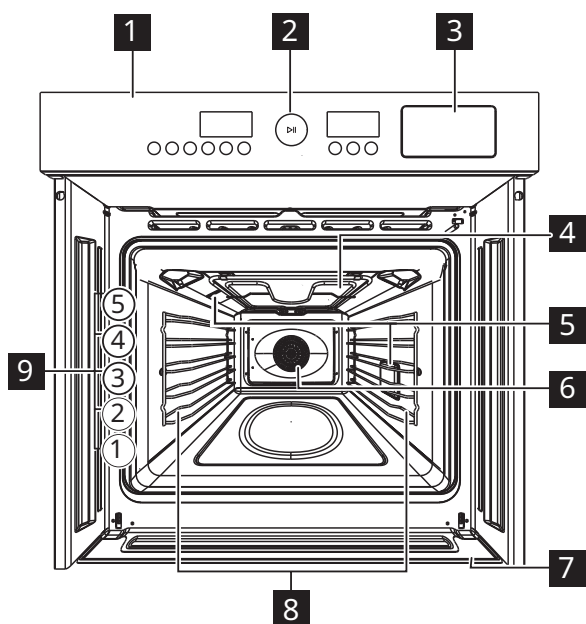

- 1 Панел за управление
- 2 Копче за настройка
- 3 Контейнер за вода
- 4 Грил
- 5 Лампа
- 6 Вентилатор
- 7 Контейнер за събиране на вода
- 8 Стойка за рафтовете, подвижна
- 9 Нива на рафтовете

Панел за управление

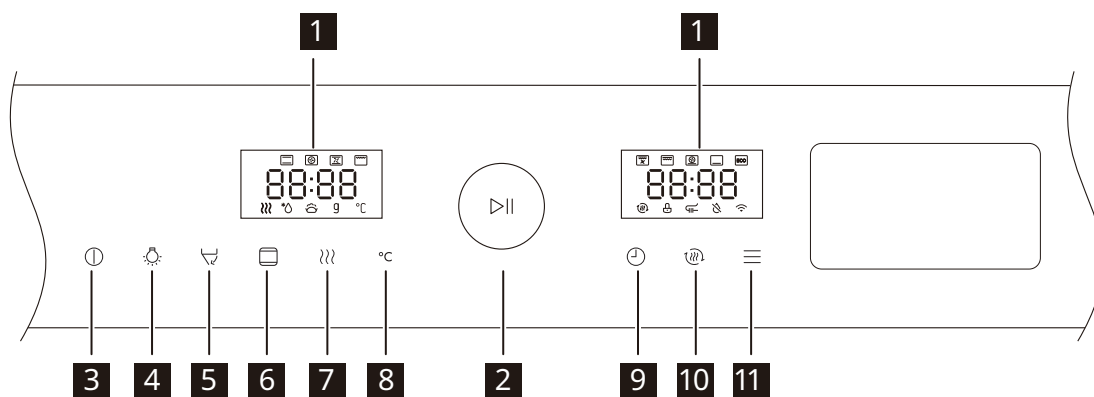

- 1 Дисплей
- 2 Въртящ се бутон
- 3 Отмяна
- 4 Лампа
- 5 Контейнер за вода
- 6 Избор на режим
- 7 Пара
- 8 Температура
- 9 Време
- 10 Бързо предварително загряване
- 11 Автоматично меню

Дисплей

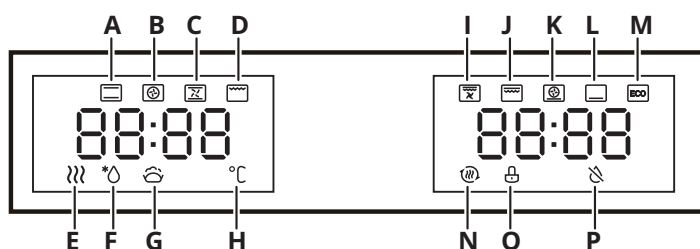

- | | |
|-----------------------------------|----------------------------------|
| A. Обикновено печене | I. Двоен грил + вентилатор |
| B. Конвекция | J. Двоен грил |
| C. Обикновено печене + вентилатор | K. Пица |
| D. Грил | L. Долен нагревател |
| E. Пара | M. ECO |
| F. Размразяване | N. Бързо предварително загряване |
| G. Уред за втасване на тесто | O. Защита от деца |
| H. Температура | P. Липса на вода |

Общ преглед на менютата

- | | | |
|--|---------------------------------------|---|
| | Обикновено печене | Печене на големи печива. |
| | Конвекция | Режимът е особено подходящ за печене на продукти, които трябва да придобият равномерно оцветяване. |
| | Обикновено печене + вентилатор | Комбинацията от вентилаторите и нагревателите осигурява още по-равномерно разпределение на топлината и спестява до 30-40% от енергията. |
| | Скара | Печене на малки количества храна. |
| | Двоен грил + вентилатор | Печене на плоски парчета храна на барбекю. |
| | Двоен грил | Печене малки количества храна на плоски парчета. |
| | Пица | Печена на пица. |
| | Долен нагревател | Печене на долната страна на плоски парчета храна. |
| | ECO | За икономично готвене. |
| | Размразяване | Размразяване на замразени храни. |
| | Уред за втасване на тесто | Втасване на тесто или приготвяне на кисело мляко. |
| | Функция за сушене | Използва се за изсушаване на фурната и предотвратяване на развитието на бактерии. |
| | Почистване на котлен камък | За премахване на котления камък в тръбичката чрез добавяне на лимонена киселина в контейнера за вода. |

Режим на готвене с функция за пара

- | | | | | | |
|--|-------------------|--|------------------|--|--------------------------------|
| | Обикновено печене | | Скара | | Обикновено печене + вентилатор |
| | Конвекция | | Долен нагревател | | Почистване с пара |

Работа с контейнера за вода

Когато поставяте контейнера за вода обратно в гнездото, трябва да го натиснете докрай в гнездото.

След приключване на готвенето изхвърлете останалата в контейнера вода и го подсушете, за да предотвратите развитието на бактерии.

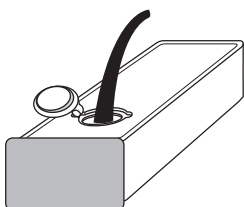

Когато използвате функцията за пара и автоматичното меню, трябва предварително да добавите пречистена вода в контейнера.

начин 1

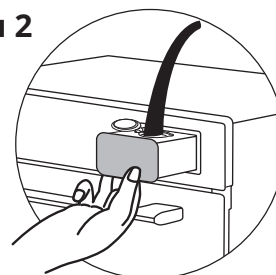

начин 2



1. Натиснете бутона „“, за да извадите целия контейнер за вода, отворете гумения пръстен и добавете вода.
2. Натиснете бутона „“ в горната част на контейнера за вода, отворете гумения пръстен и добавете вода.

Отстраняване на неизправности

Ако възникне проблем с уреда, направете справка в раздела „Какво да направите, ако...“ в пълната версия

на Ръководството за потребителя, публикувано на: www.ikea.com.

Таблица с автоматичните менюта

Дисплей	Меню	Режим или температура	Време	Предварително загряване
A01	Печени говежди ребра	 250°C	4 мин.	ДА
A02	Телешка пържола с черен пипер	 250°C	8 мин.	ДА
A03	Торта „Шифон“	 150°C	50 мин.	ДА
A04	Торта „Червено кадифе“	 160°C	35 мин.	ДА
A05	Печена свинска пържола	 200°C	50 мин.	ДА
A06	Италиански плодов пай (8 инча)	 190°C	22 мин.	ДА

A07	Еклери	 190°C	24 мин.	ДА
A08	Печена риба треска	 250°C	8 мин.	ДА
A09	Печени пилешки крилца	 L1 230°C	25 мин.	ДА
A10	Печени свински ребра	 L1 200°C	25 мин.	НО
A11	Печена риба сайра	 L1 220°C	14 мин.	ДА
A12	Цяло печено пиле	 L1 200°C	45 мин.	ДА
A13	Печено свинско	 L1 180°C	50 мин.	ДА
A14	Печена агнешка пържола	 L1 220°C	25 мин.	ДА
A15	Печен свински джолан	 L1 230°C	80 мин.	НО
A16	Чийзкейк	 L1 160°C	55 мин.	ДА
A17	Шоколадов кекс с боровинки	 L1 180°C	25 мин.	ДА
A18	Кекс с ядки	 L1 190°C	30 мин.	ДА

Технически данни

Технически данни

Размери (вътрешни)	Ширина Височина Дълбочина	503 mm 353 mm 386 mm
Площ на тавата за печене	1159 cm ²	
Горен нагревател	900 W	
Долен нагревател	1500 W	
Грил	1300 W	
Пръстеновиден нагревател	1800 W	
Обща мощност	3150 W	

Технически данни

Напрежение	220 - 240 V~
Честота	50 - 60 Hz
Брой функции	14

Технически данни**Технически данни**

Размери (вътрешни)	Ширина	503 mm
	Височина	353 mm
	Дълбочина	386 mm
Площ на тавата за печене	1159 cm ²	
Горен нагревател	900 W	
Долен нагревател	1500 W	
Грил	1300 W	
Пръстеновиден нагревател	1800 W	
Обща мощност	3150 W	

Технически данни

Напрежение	220 - 240 V~
Честота	50 - 60 Hz
Брой функции	14

Енергийна ефективност

Информация за продукта и информационен лист на продукта*

Име на доставчика	IKEA
Идентификация на модела	MÅGEBO 905-570-61
Индекс на енергийна ефективност	76,9
Клас на енергийна ефективност	A+
Консумация на електроенергия при стандартен товар, нормален режим	1,02 kWh
Консумация на електроенергия при стандартен товар, режим с вентилатор	0,65 kWh
Брой камери	1
Източник на топлина	Електричество
Сила на звука	72 l
Тип фурна	Вградена фурна
Маса	43,5 kg
* За Европейския съюз - съгласно Регламенти на ЕС 65/2014 и 66/2014. За Република Беларус - съгласно стандарт STB 2478-2017, Приложение G; STB 2477-2017, Анекси А и В.	
Класът енергийна ефективност не е приложим за Русия.	
EN 60350-1 - Битови електрически уреди за готвене. Част 1: Печки за готвене, фурни, фурни за готвене на пара и грилове. Методи за измерване на работните характеристики.	

Ürün açıklaması

Genel bakış

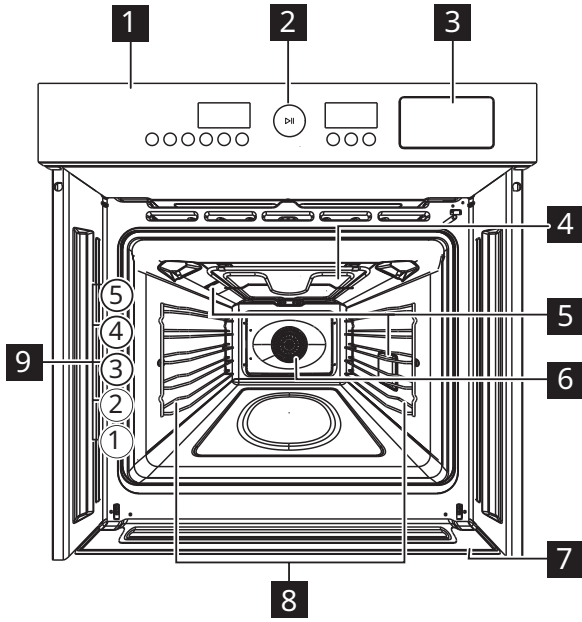

- 1 Kontrol paneli
- 2 Ayar düğmesi
- 3 Su çekmecesi
- 4 Izgara
- 5 Lamba
- 6 Fan
- 7 Su toplayıcı
- 8 Raf desteği, çıkarılabilir
- 9 Raf konumları

Kontrol paneli

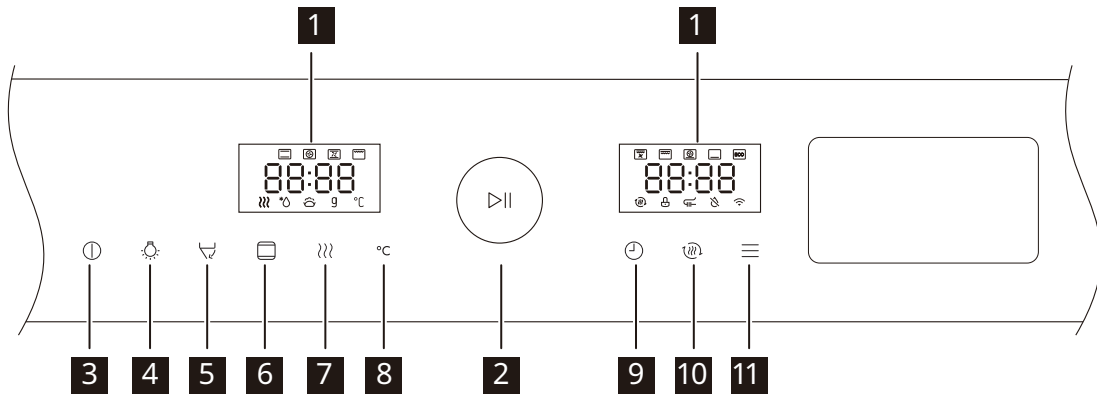

- 1 Ekran
- 2 Kontrol düğmesi
- 3 İptal
- 4 Lamba
- 5 Su haznesi
- 6 Mod seçimi
- 7 Buhar
- 8 Sıcaklık
- 9 Zaman
- 10 Hızlı ön ısıtma
- 11 Otomatik Menü

Ekran

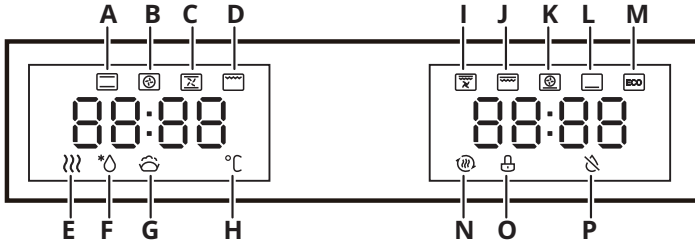

- | | |
|----------------------|--------------------|
| A. Klasik pişirme | J. Çift ızgara |
| B. Turbo fan | K. Pizza |
| C. Klasik + fan | L. Alt ısıtma |
| D. Izgara | M. Ekonomik |
| E. Buhar | N. Hızlı ön ısıtma |
| F. Buz çözme | O. Çocuk kilidi |
| G. Hamur prova | P. Su az |
| H. Sıcaklık | |
| I. Çift ızgara + fan | |

Menülere genel bakış

- | | | |
|--|--------------------------|---|
| | Klasik pişirme | Büyük kek pişirme. |
| | Turbo fan | Özellikle eşit şekilde pişmesi gereken yiyeceklerin pişirilmesi için uygundur. |
| | Klasik + fan | Fanlar ve ısıtma elemanlarının kombinasyonu, %30-40'a kadar enerji tasarrufu sağlayarak daha homojen bir ısı girişi sağlar. |
| | Izgara | Az miktarda yiyecek pişirin. |
| | Çift ızgara + fan | Yassı yiyecekleri ızgara yapın. |
| | Çift ızgara | Az miktarda yassı gıdaları pişirin. |
| | Pizza | Pizza pişirme. |
| | Alt ısıtma | Yassı gıdaların altlarını pişirir. |
| | Ekonomik | Enerji tasarruflu pişirme için. |
| | Buz çözme | Donmuş gıdaların buzunu çözün. |
| | Hamur prova | Hamur veya yoğurt mayalayın. |
| | Kurutma işlevi | Fırın haznesini kurutarak bakteri üremesini önlemek için kullanılır. |
| | Kireç giderme | Su haznesine sitrik asit ekleyerek borudaki kireci gidermek için. |

Buhar desteği işlevli pişirme modu

- | | | | | | |
|--|-----------------------|--|-------------------|--|--------------------------|
| | Klasik pişirme | | Izgara | | Klasik + fan |
| | Turbo fan | | Alt ısıtma | | Buharla temizleme |

Su haznesinin kullanılması

Su haznesini tekrar hazne yuvasına yerleştirirken su haznesinin sonuna kadar itildiğinden emin olun.

Piştirme işleminden sonra su haznesinde kalan suyu atın ve bakteri üremesini önlemek için silerek kurulayın.

Buhar desteği işlevini ve otomatik menüyü kullanırken lütfen su haznesine önceden arıtılmış su koyun.

1. yöntem

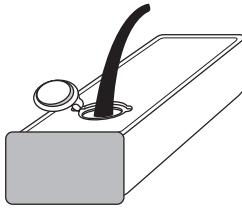

2. yöntem

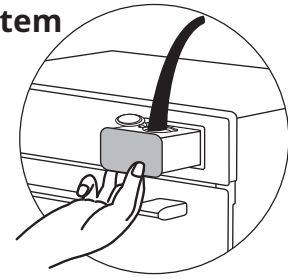









1. Su haznesini tamamen çıkarmak için "↖" tuşuna basın, lastik kapağı açarak suyu koyun.
2. Su haznesini dışarı çıkarmak için "↗" tuşuna basın, lastik kapağı açarak suyu koyun.

Sorun Giderme

Cihazınızla ilgili bir sorunla karşılaşırsanız Kılavuzunun tam sürümündeki "Ne yapmalı..." bölümüne bakın. www.ikea.com adresinde bulunan Kullanım

Otomatik menü sayfası

Ekran	Menü	Mod veya Sıcaklık	Zaman	Ön ısıtma
A01	Fırında dana kaburga	 250°C	4 dak.	EVET
A02	Kara biberli biftek	 250°C	8 dak.	EVET
A03	Şifon Kek	 150°C	50 dak.	EVET
A04	Kırmızı kadife kap kek	 160°C	35 dak.	EVET
A05	Fırında kızarmış pirzola	 200°C	50 dak.	EVET
A06	İtalyan meyveli tart (20 cm)	 190°C	22 dak.	EVET
A07	Profiterol	 190°C	24 dak.	EVET
A08	Fırında morina	 250°C	8 dak.	EVET

A09	Fırında tavuk kanatları	 L1 230°C	25 dak.	EVET
A10	Fırında kaburga	 L1 200°C	25 dak.	HAYIR
A11	Fırında zargana	 L1 220°C	14 dak.	EVET
A12	Fırında bütün tavuk	 L1 200°C	45 dak.	EVET
A13	Fırında et	 L1 180°C	50 dak.	EVET
A14	Kızarmış kuzu pirzola	 L1 220°C	25 dak.	EVET
A15	Fırında Kızarmış İncik	 L1 230°C	80 dak.	HAYIR
A16	Cheese cake	 L1 160°C	55 dak.	EVET
A17	Çikolatalı yaban mersinli ekmek	 L1 180°C	25 dak.	EVET
A18	Cevizli ekmek	 L1 190°C	30 dak.	EVET

Teknik veriler

Teknik veriler

Boyutlar (iç)	Genişlik Yükseklik Derinlik	503 mm 353 mm 386 mm
Fırın tepsisinin alanı	1159 cm ²	
Üst ısıtma elemanı	900 W	
Alt ısıtma elemanı	1500 W	
Izgara	1300 W	
Yuvarlak ısıtıcı eleman	1800 W	
Toplam nominal güç	3150 W	

Teknik veriler

Gerilim	220 - 240 V~
Frekans	50 - 60 Hz
İşlev sayısı	14

Teknik veriler**Teknik veriler**

Boyutlar (iç)	Genişlik Yükseklik Derinlik	503 mm 353 mm 386 mm
Fırın tepsisinin alanı	1159 cm ²	
Üst ısıtma elemanı	900 W	
Alt ısıtma elemanı	1500 W	
Izgara	1300 W	
Yuvarlak ısıtıcı eleman	1800 W	
Toplam nominal güç	3150 W	

Teknik veriler

Gerilim	220 - 240 V~
Frekans	50 - 60 Hz
İşlev sayısı	14

Enerji verimliliği**Ürün Bilgileri ve Ürün Bilgi Formu***

Tedarikçinin adı	IKEA
Model kimliği	MÅGEBO 905-570-61
Enerji Verimliliği Endeksi	76,9
Enerji Verimliliği Sınıfı	A+
Standart bir yükte enerji tüketimi, klasik pişirme modu	1,02 kWh
Standart bir yükte enerji tüketimi, fanlı pişirme modu	0,65 kWh
Fırın bölümü sayısı	1
Isı kaynağı	Elektrik
Hacim	72 lt
Fırın türü	Ankastre fırın
Ağırlık	43,5 kg
* AB Yönetmelikleri 65/2014 ve 66/2014 uyarınca Avrupa Birliği için. STB 2478-2017, Ek G; STB 2477-2017, Ek A ve B uyarınca Beyaz Rusya Cumhuriyeti için. Enerji verimliliği sınıfı, Rusya için geçerli değildir.	
EN 60350-1 - Evde kullanım için elektrikli pişirme cihazları - Bölüm 1: Ocaklar, fırınlar, buharlı fırınlar ve ızgaralar - Performans ölçüm yöntemleri.	

